

Blower Door Operation

Manual

For Series 200, 1000,
2000 and 3000 systems

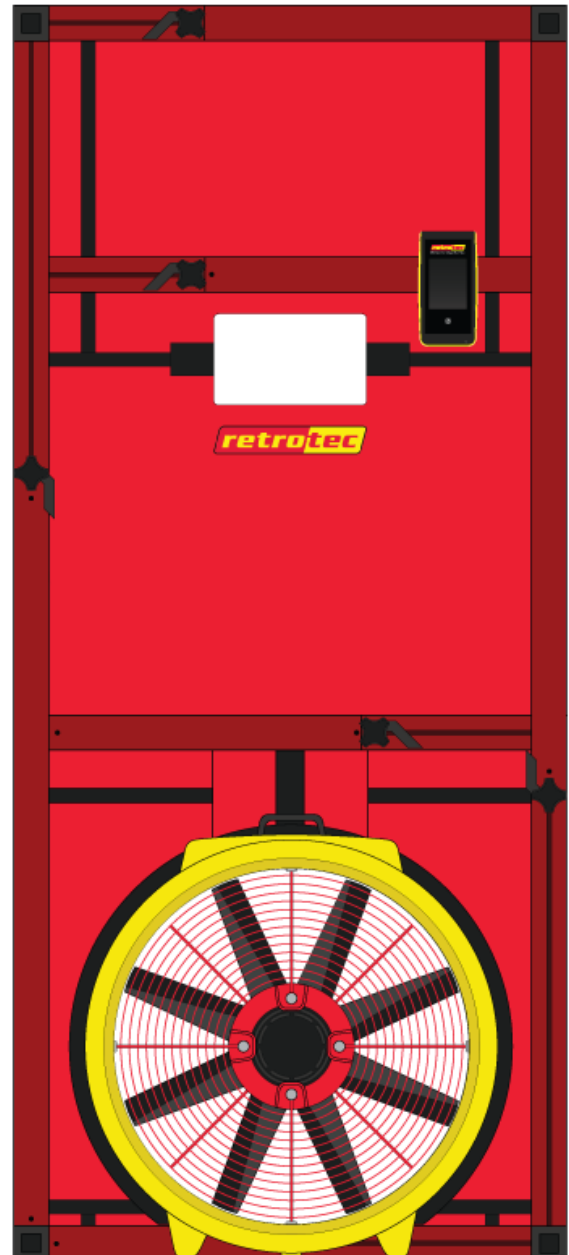

Made by Retrotec

1060 East Pole Road

Everson, WA USA 98247

For support:

Call 1(888) 330-1345 in USA

+1 (360) 738-9835 outside USA support@retrotec.com or

Fax +1(360) 647-7724

Manual for:

Previous Models Q46, Q56, Q4E, Q5E, Q4E-2X, Q5E-2X

Series 200, 1000, 1100, 1200, 1300, 2000, 2100, 2250, 3100, 3200, and 3300

Series 1000 includes the following Models*:

Model 1100 with DM-2 gauge

Model 1101 with DM32

Model 1102 with DM32 WiFi

*See appendix E for complete Model list

rev-2015-03-16 Model numbers updated. Sections 5.7 and 5.8 added.

Copyright © 2012-2017 Retrotec

All rights reserved.

This document contains materials protected under International and Federal Copyright Laws. No part of this book may be reproduced or transmitted in any form or by any means, electronic or mechanical, including photocopying, recording, or by any information storage and retrieval system without express written permission from Retrotec

Retrotec makes no warranties with respect to this documentation and disclaims any implied warranties of merchantability, quality, or fitness for any particular purpose. The information in this document is subject to change without notice. Retrotec reserves the right to make revisions to this publication without obligation to notify any person or entity of any such changes.

DucTester, Infiltrometer and FanTestic are Trademarks of Retrotec Other trademarks or brand names mentioned herein are trademarks or registered trademarks of their respective owners.

Retrotec test fans, blower door systems, duct testing systems and gauges have been calibrated in our laboratory which is accredited by the ANSI-ASQ National Accreditation Board to meet requirements of international standard ISO/IEC 17025:2005. All pressure and flow devices used in the calibration are traceable to the National Institute of Standards and Technology and themselves have ISO 17025 accreditation.

Retrotec equipment and software complies with the following standards:

ASTM E779-10, ASTM E-1554, ATTMA TSL1, ATTMA TSL2, CGSB 149.10, DW/143, Energy Star, EN12237, EN13829, EN15004, FD E51-767, ISO 9972-2015, ISO 14520-2006, NEN2686, NFPA 2001-2015, RESNET, SMACNA-2002, All USA State Energy Codes, Title 24 and USACE Protocol.

*Custom calibration available upon request

Range Configurations L4, L2, L1 have measurement accuracies of $\pm 10\%$ and are not compliant with any of the standards specified above.

Table of Contents

Important equipment-related safeguards.....	8
Important occupant safeguards during testing.....	9
1. How the Blower Door System components work.....	10
1.1 How the Calibrated Fan creates flow and Fan Pressure.....	11
1.2 Range configurations restrict the fan’s air flow	12
1.3 The Door Panel seals off a doorway and provides a fan mount.....	13
1.4 Gauge measures two pressures during the test.....	13
1.5 A Fan Speed Controller sets the test pressure	16
1.5.1. Use Speed Control Knob on the fan.....	16
1.5.2. Control fan speed with a DM-2 gauge	16
1.5.3. Use a Manual Speed Control accessory.....	16
1.5.4. Use a Speed Control Splitter to control multiple fans	17
2. Choose a calibrated fan suited to your application	21
2.1 Model 1000 for testing homes	21
2.2 Models 3300 and 3300SR high flow fans	21
2.3 Model 200 (DucTester) or 300 fans for tight houses	22
2.4 Model 2350 for multiple fan applications	24
2.5 Model 2100 fans (no longer available).....	24
2.6 Model 2200 fan (no longer available)	25
3. Choose a Door Panel based on size of door and fans	27
3.1 Cloth Door Panel with Aluminum Frame.....	27
3.1.1. Using the Aluminum Frame	28
3.1.2. Available Aluminum Frame Part Replacements	30
3.2 Modular Hard Sided Door Panels	30
3.2.1. Modular Door Panel Instructions.....	31
3.3 Triple-Fan Molded Panel Set for multiple fan tests.....	32
3.3.1. Using the Triple-Fan Molded Panel Set	32
3.4 Compensating for Pa	

nel leakage.....	33
4. Conduct a Test.....	35
4.1 Observe house to avoid problems during testing	35
4.1.1. Ashes and other materials can blow into house.....	35
4.1.2. Doors can slam shut.....	35
4.2 Select a Location.....	35
4.3 Where to place the exterior Pressure pickup tube	35
4.4 Determine if corrections for temperature difference are required.....	36
4.5 Install the Door Fan for Depressurization test	36
4.6 Set up the Gauge for the Appropriate Test	37
4.7 Connect a Fan to the gauge (DM-2 or DM32)	37
4.8 Select the correct Range configuration	38
4.9 Determine which Range to use on a Door Fan.....	39
4.10 Cannot reach required pressure?	39
4.11 Choose either a Single or Multi- Point Test Procedure	39
4.12 Taking Manual Single Point Readings.....	40
4.12.1. Measure the Baseline Pressure before turning the fan on	40
4.12.2. Adjust your test fan manually.....	40
4.12.3. Adjust your test fan using Set Pressure	40
4.13 Taking Manual Multi-Point Readings for FanTestic Software	41
4.13.1. Decide how many test points to take	41
4.13.2. Decide whether to test in both directions.....	42
4.13.3. Decide what is the optimum opening size on the fan (Range).....	42
4.13.4. Measure the Baseline (Zero Flow) Pressure before the test	42
4.13.5. Measure each of the target points required for the test	43
4.13.6. Complete taking the data set for this direction.....	44
4.13.7. Take another data set with fan flow in the other direction	44
4.13.8. Enter collected data into FanTestic to get Results	44
4.14 Completely automated results using FanTestic	45
4.15 Basic Results from Single Point Test.....	47
4.15.1. Air Leakage at 50 Pascal.....	47
4.15.2. Air Changes per hour at 50 Pa - ACH50	47
4.15.3. Equivalent Leakage Area - EqLA 10.....	47
4.15.4. Effective Leakage Area - EflA 4.....	47
4.16 Results from Multi-Point Procedure.....	47

5. Avoid Common Sources of Error	48
5.1 Wrong Range Configuration or Device	48
5.2 No Reference Tube when Pressurizing.....	48
5.3 Incorrect @ Pressure usage.....	48
5.4 Choose the Appropriate Test Direction.....	48
5.5 Minimize effects of upstream Air Flow conditions.....	48
5.6 Considerations when operating with high backpressure	49
6. Maintain system for optimum operation.....	49
6.1 Check motor and fan blade position	52
6.2 Check for Flow Sensor leaks	52
6.3 Perform a field verification monthly	52
7. Power to run the fan and gauge	54
7.1 Status lights indicate power and control connections are ready to go.....	54
7.2 Using the Fan with Mains Power.....	54
7.3 Using the Fan with a power generator.....	54
7.4 Recommended Generators	55
7.4.1. Honda Generator EU2000 (120V, 2000W, 67 lbs)	55
7.4.2. GENYX G3000HI (230V, 3000W) generator	55
7.5 Portable Power Supplies for DucTester.....	56
7.5.1. Black and Decker Electromate 400 Model VEC026BD.....	56
8. Fan Troubleshooting.....	57
8.1 Retrotec 2000 series 120 Volt AC motors overheat and shut off	57
8.2 3300 High Power Fan will not control smoothly	57
8.3 3300 Fan will not start.....	58
8.4 Power supply interior status light fault codes.....	59
Appendix A: Calculate Airflow Manually	60
Appendix B: Find correct CFM at particular fan pressure.....	61
Appendix C: Find Door Fan System Part Numbers	69
Fans & Accessories	69
Aluminum Frame	70
Cloth Door Panels	71
Modular Door Panels.....	73
Digital Gauges.....	75
System Accessories.....	75

Appendix D: Optional Door Fan system components78
Flex Duct to measure air flow or neutralize pressure drops78
Wind Damping Kits to minimize wind effects 79
Cases and Bags..... 79
Grill Mask and Dispensers 79
Air Current Testers..... 79
Appendix E: Model and System Names81
Glossary86

Important equipment-related safeguards

READ AND SAVE THESE INSTRUCTIONS

When using electrical appliances, basic safety precautions should always be followed. If Retrotec equipment is used in a manner that does not follow the information provided in this manual, safety to the operator and equipment performance may be impaired.

The risk of fire, electric shock, and injury to persons may result during cleaning and user-maintenance of the fan. To avoid these risks, unplug or disconnect the fan from the electrical power supply before servicing. Any and all safety devices removed for any reason shall be reinstalled or remounted as previously installed before plugging the fan into electrical power.

To protect against the risk of fire, electric shock, and injury to persons during fan operation:

Do not operate any fan with a damaged electrical cord. Discard fan or return to an authorized service facility for examination and/or repair.

Do not run cord under carpeting. Do not cover cord with throw rugs, runners, or similar coverings. Do not route cord under furniture or appliances. Arrange cord away from traffic area and where it will not be tripped over.

Do not place this equipment or power cord in water or other liquid.

Use only the included power plug to operate the fan. Do not use ungrounded outlets or adapter plugs. Never remove or modify the grounding prong.

Turn the unit off and unplug from electrical outlet before moving and when not in use, and when making any adjustments to the fan motor, blades or electrical components.

For use under indoor conditions only, where there is no exposure to water or dusty substances or explosive materials or flammable materials.

Do not use equipment for other than its intended use.

Equipment is intended for diagnostic testing and to be operated for brief periods under supervision by a qualified operator. Not to be used in a role as a household appliance for the purpose of moving air. The fan is designed to be used while mounted in the Door Panel.

At high-speed, the fan can tip over if not secured properly. The fan can cause damage or injury if it were to fall on someone/something.

Do not stand on the fan, or use the fan to support the weight of another object.

Press the power plug firmly into the power receptacle on the fan. Failure to do so can cause over-heating of the power cord and damage the fan.

Avoid contact with moving parts. Keep hands, hair and clothing away from fan at all times. Special attention should be made to keep children and pets away from the fan when it is operating.

Do not insert anything into the fan casing while the fan is moving.

Ensure that no debris is inside the fan casing before operating the fan.

Ensure proper cooling of the fan motor.

If the motor gets too hot, the thermal overload protection will shut-down the fan. When this happens, turn the controller off, so that the fan does not restart unexpectedly after it cools down.

During prolonged operation, such as when maintaining building pressure while air-sealing, use Range Ring A.

Failure to follow these instructions carefully may result in bodily injury, damage to property and/or equipment failure. Failing to operate equipment as intended may void warranty and compliance with CE mark and other listings.

Important occupant safeguards during testing

Please read the following carefully before carrying out tests:

The fan can move a significant amount of air, causing papers or other light flat objects such as pictures to be thrown around. Ensure that loose items are secured.

If dust, pollen, mold spores, chemicals, asbestos, vermiculite dust, fiberglass dust, cellulose dust, lead paint dust or other undesirable substances can get blown into living spaces, keep those susceptible to these substances away from the test area, and wear dust masks or do not test.

Do not pressurize an enclosure with air that is polluted or exposed to any toxic substances. For example, blowing air from a garage into a house while a motor vehicle is running can quickly fill a house with toxic carbon monoxide.

Cover exposed ashes or test at or below 25 Pa to avoid blowing ashes from open fire pits.

Do not pressurize a duct system with air that is polluted or exposed to any toxic substances. For example, blowing air from a car-port into a house or duct system while a motor vehicle is running can quickly fill a house with toxic carbon monoxide.

Air sealing duct work may change the pressure balance in a house and cause back drafting where it did not occur before. For example, a return leaking to outdoors may have pressurized a house but when corrected, leaky supplies may reverse that and cause depressurization which could result in back drafting hot water heaters, furnaces or fireplaces.

Be aware of all possible sources of combustion. Ensure any appliances do not turn on during the test. Turn off power to the appliance, or set the appliance to the "Pilot" setting. It is possible for flames to be sucked out of a combustion air inlet (flame rollout) during a test, which is a fire hazard and can result in high carbon monoxide levels.

If there are attached spaces (e.g. townhouses) that could contain a vented combustion appliance, either adjust those appliances to prevent them from turning on during the test, or be sure that the attached spaces are not depressurized or pressurized when the Door Fan is operating.

If combustion safety problems are found, tenants and building owners should be notified immediately and steps taken to correct the problem (including notifying a professional heating contractor if basic remedial actions are not available). Remember, the presence of elevated levels of carbon monoxide in ambient building air or in combustion products is a potentially life threatening situation. Air sealing work should not be undertaken until existing combustion safety problems are resolved, or unless air sealing is itself being used as a remedial action.

Failure to follow these instructions carefully may result in bodily injury, damage to property and equipment failure.

1. How the Blower Door System components work

A Door Fan is a specially designed calibrated fan which, as part of the Blower Door Fan System, is temporarily mounted in a doorway. The fan is used to blow air into or out of a room, house, or building to measure the air leakage of the enclosure. The term “room, house, or building” is often shortened to “enclosure”.

The Door Fan System works by establishing a pressure difference between the inside and the outside of an enclosure. The pressure difference forces air to leak through all of the holes in the exterior envelope of the enclosure. The amount of air flow that is required to maintain a constant pressure difference is equal to the amount of air that is leaking from the enclosure. A specially designed gauge can thus be used to measure the pressure difference and calculate the amount of air flowing through the Door Fan, which can then be used to determine the total size of all those leaks.

A typical Door Fan or Door Fan system is comprised of four main parts:

1. A Door Panel, which temporarily seals a typical doorway and provides a hole to mount a fan.
2. A calibrated fan, capable of creating a measurable flow of air.
3. A two-channel differential pressure gauge that can also calculate flow for a particular fan.
4. A fan speed controller to change the air flow through the fan (which can be provided by the gauge)

A typical Door Fan system breaks down as shown in Figure 1:

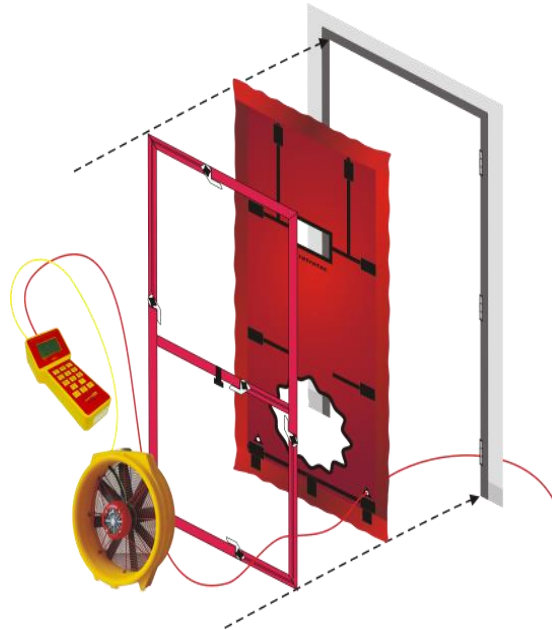

Figure 1: The breakdown of a typical Door Fan system.

In this case, an aluminum frame holds a Cloth Door Panel in place, sealing the doorway. The fan is mounted in the hole in the cloth, and is supported by the aluminum frame crossbar. The gauge is acting as both the fan controller and differential pressure gauge.

In its role as differential pressure gauge, one channel of the gauge is connected to the fan through a yellow tube to measure the Fan Pressure, (referenced to the pressure at the green port of the gauge), which is the pressure required for the fan to bring the enclosure to the desired pressure. The other channel of the gauge is measuring the pressure difference between the area in which the gauge is

located (on the blue port of the gauge) and the other side of the doorway, since the red tube is run through a small hole in the cloth to the other side of the doorway and acts as a reference for the measurement.

In its role as a fan speed controller, the gauge is connected to the fan through an electrical connector, (yellow Speed Control Cable), and changes the speed of the fan until the pressure difference across the doorway reaches the desired test condition. The Speed Control Cable can extend approximately 1,200 meters (4,000 feet) between the gauge and the fan.

Knowing the pressure difference tells the operator when the enclosure has reached the desired condition (50 Pa for instance). Knowing the Fan Pressure and the fan calibration allows the operator, or the gauge itself, to calculate the air flow (CFM for instance).

1.1 How the Calibrated Fan creates flow and Fan Pressure

When the fan is turned on, air starts moving through the fan housing. In order for the air to be pulled through the holes on the inlet side, there must be suction. The rotating fan blade creates a suction pressure (which is also called Fan Pressure) between the inlet opening and the fan blade. Range Rings and Plates are typically installed on the inlet side of the fan housing to artificially restrict flow, control the amount of air going through the fan, and thus control the Fan Pressure.

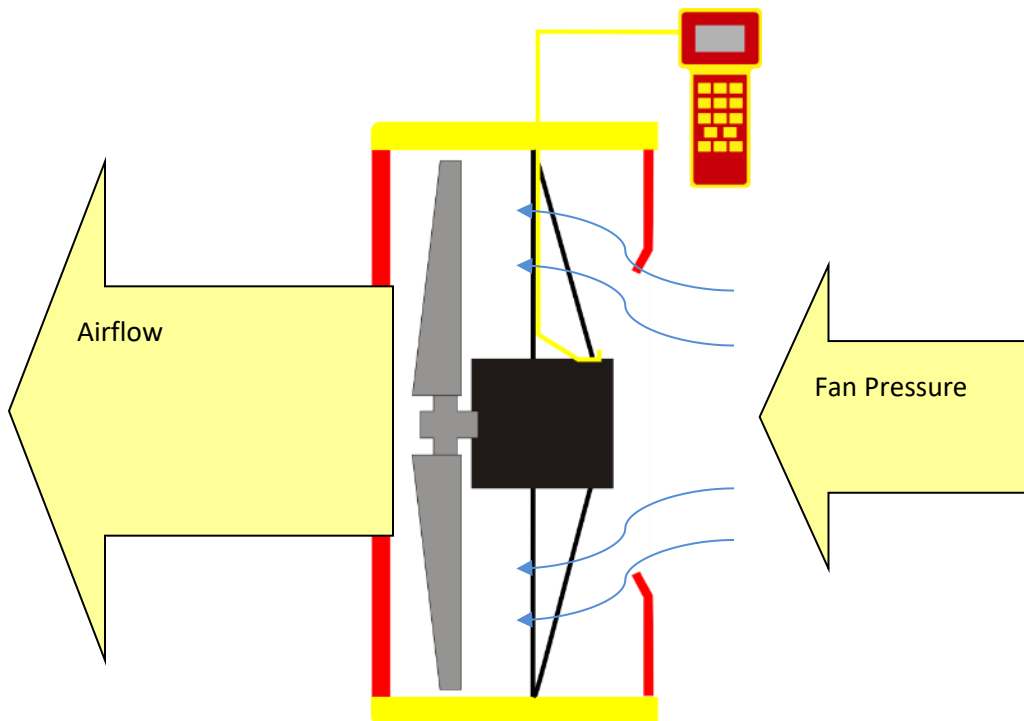

Figure 2: Pictorial display of how a calibrated Door Fan works.

By measuring the Fan Pressure developed across the fan housing, and knowing the size of the hole(s) in the installed Range, we can calculate the volume of air moving through the fan.

When flow is away from the operator, the Fan Pressure signal will always be correct and will not need adjusting. The gauge can determine if flow is away from the operator because pressure

When the flow is towards the operator, the Fan Pressure reading is affected by the pressure in the area into which the air is flowing. The area which is being pressurized will exert pressure at the gauge green port which will be picked up and included as part of the measured pressure difference. The measured Fan Pressure, shown when Pressure is the Result being displayed on the gauge, will

thus include the actual Fan Pressure as well as the additional pressure in the room where the operator is standing. So when the flow is towards the operator, this room pressure must be removed from the measurement to get the true Fan Pressure, before calculating flow.

A self-referencing fan avoids the need for adjusting Fan Pressure measurements by measuring the pressure difference at the fan inlet directly with both the green and yellow tubes connected to either side of the fan inlet on Retrotec fans. The Fan Pressure difference is thus always correct when measured between the yellow and green port at the gauge.

If a self-referencing fan is in use (both yellow and green tubes are connected between the fan and the gauge), it is imperative to choose 3000SR for the Device on the gauge (or the DucTester), so the gauge does not compensate for the room pressure in any situation.

The gauge can determine when flow is toward the operator because the readings on Channel A will always be positive (assuming the gauge is set up with the blue port measuring the pressure of the room in which the operator is standing, and the red tube runs to the opposite side). Thus, if a device that is not self-referencing is chosen on the gauge, (any device except the DucTester and those denoted SR), and Channel A readings are positive, the gauge compensates: the measured pressure from the fan, "PrB", is reduced by the room pressure being measured on Channel A, "PrA". The gauge then uses the adjusted value, the actual Fan Pressure, to calculate the airflow displayed as Mode "Flow" or any other Mode result except "PrB". When the Mode is set to "PrB", the gauge always shows the actual pressure difference measured on Channel B, which includes both the fan pressure and the additional pressure in the room where the operator is standing, when flow is towards the operator.

Other manufacturers' digital gauges need to have the pressure signal from the fan corrected to the actual Fan Pressure before the Fan Pressure value is used to calculate air flow. When flow is towards the operator, the procedure is to subtract the Room Pressure from the Fan Pressure to determine the actual Fan Pressure.

1.2 Range configurations restrict the fan's air flow

A Door Fan measures flow by measuring the Fan Pressure (usually on Channel B of the gauge). As the fan blades spin, a suction pressure develops in the fan that causes air to flow. By measuring this suction pressure (Fan Pressure), airflow can be calculated.

When there is not much air flow through the fan, the Fan Pressure becomes too small to accurately measure. To bring the Fan Pressure up into a more accurate range, while not changing the volume of air being moved, a restriction is placed in front of the fan. Because of the restricted area through which to move air, the fan has to spin faster to move the same volume of air. The suction or Fan Pressure thus increases to where it can be accurately measured again.

The calibrated fans are provided with a set of Ranges which are metal rings and plates with holes in them. Each inlet size has a pre-established range of air flows that it will allow the calibrated fan to accurately measure. By providing a set of flow restricting plates with ever smaller holes (Ranges), the Retrotec Fans can accurately measure flow from 5 CFM to 8300 CFM (2 to 3917 litres per second or 8 to 14,100 cubic meters per hour).

Range Configurations are somewhat analogous to gears in a standard transmission. The lower the air flow, the smaller the hole required to maintain a readable Fan Pressure.



Figure 3: Range Configuration components for 2000/3000 series fans.

See section 4.3 and 4.9 for details on how to select the correct Range Configuration for the test.

1.3 The Door Panel seals off a doorway and provides a fan mount

Retrotec offers three types of Door Panels. The most common style of Door Panel is a Cloth Door Panel on an aluminum frame. Modular Door Panels are a set of solid panels that expand to fit most doors, and offer a quick setup or take down option that is professional looking and easy to carry. For large buildings, three fans can be mounted in one Three-Fan Panel, to maximize the airflow pushed through one doorway.

See section 3 for details on each type of Door Panel, and set up instructions.

1.4 Gauge measures two pressures during the test

The Retrotec digital gauges (DM32 or DM-2) are two channel differential pressure gauges. A differential pressure gauge measures the pressure difference between two locations. The gauge provides two channels, each of which can measure a pressure difference (between 2 ports). Channel A measures the difference in pressure between the blue and red ports, and Channel B measures the pressure difference between the green and yellow ports. The gauge can also provide fan speed control functions, as outlined in section 0.

In its role as a two channel differential pressure gauge during the Blower Door test, one channel of the gauge is used to measure the Fan Pressure and one channel is used to measure the Room or Induced Pressure. The Fan Pressure is the pressure inside the fan that is developed while the fan brings the room to the test pressure. The Room or Induced Pressure is the pressure difference between the area in which the gauge is located, and the other side of the Door Panel.

To measure the Fan Pressure difference between the fan interior and the pressure at the green port on the gauge, the yellow port on the gauge is connected to the fan through a yellow tube. If the fan provides a green port (fan is self-referencing), the green port on the gauge should also be connected to the green port on the fan.

To measure Room Pressure, the red tube is connected to the red port on the gauge and then run through a small hole in the cloth to the other side of the Door Panel. The blue port on the gauge is open to the pressure in the room so the difference between the pressure in the room and the other side of the Door Panel is measured on Channel A.

It is very simple to connect a Retrotec fan to the digital gauge. Depending on which model fan is in use, there will be some combination of red, blue, green, and yellow pressure tubes included. These

tubes connect to their corresponding color coded ports on the gauge. The Speed Control Cable connects to the port marked "Speed Control", and can be up to 1200 m (4000 ft) long.

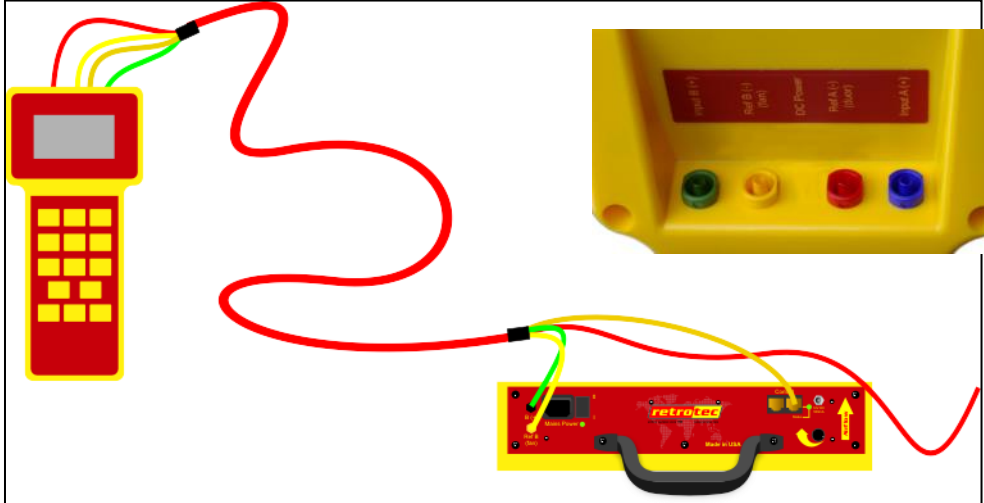

Figure 4: DM-2 to fan connection.

For details on how to connect the DM-2 gauge to a calibrated fan, see section 4.10

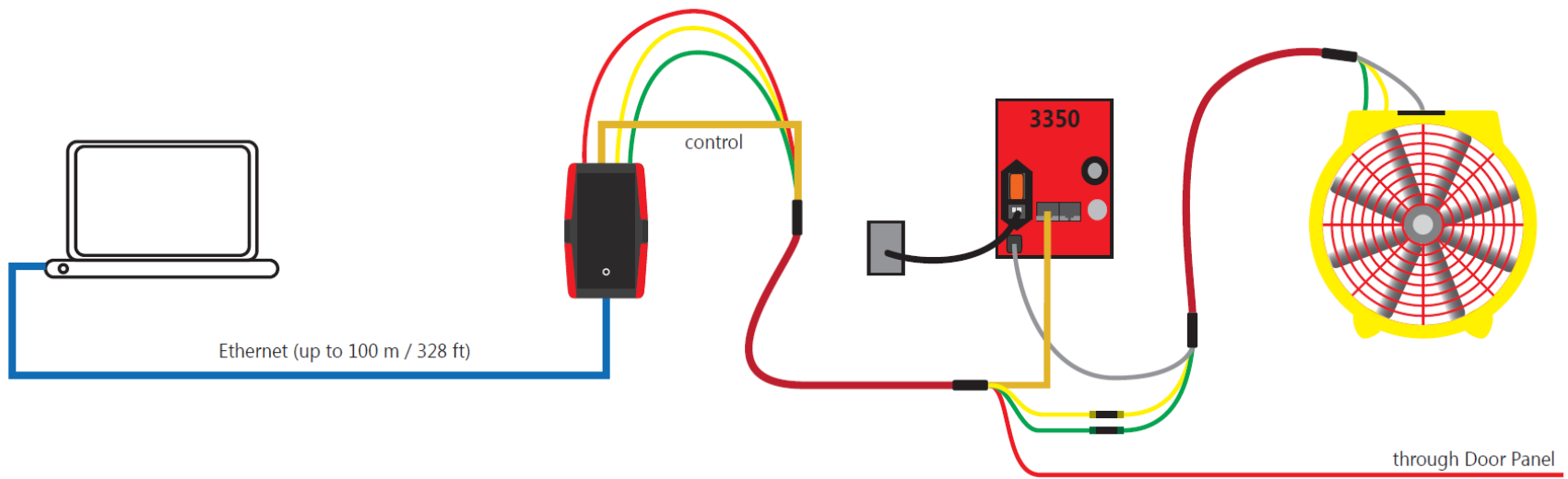

Figure 5. Connections between a Door Fan, 3350 Drive, DM32 gauge, and laptop. Dimensions are not shown to scale.

For Multi-fan setup configurations, refer to [Manual-Lge-Multi-Fan Testing](#).

1.5 A Fan Speed Controller sets the test pressure

If operating the Blower Door Fan System manually, a knob on the fan or a Manual Speed Control accessory allows the speed of a fan to be controlled by turning a knob/dial. Otherwise, speed can be controlled from the DM-2 or DM32 gauge.

The gauge can operate as a fan speed controller in addition to being a two channel differential pressure gauge. In its role as a fan speed controller, the gauge is connected to the fan through an electrical control connector and changes the speed of the fan until the pressure difference across the doorway reaches the desired test condition.

For instructions on connecting and operating each controller, see section 1.5.1 for the Fan Top speed control, section 1.5.3 for the Manual Speed Control accessory, and section 1.5.2 to operate the gauge speed control function.

The Fan Speed Control output on the gauge speed control cable which connects to the fan uses RS-485 protocol. This protocol allows the Speed Control Cable to extend approximately 1,200 metres (4,000 feet) between the gauge and the fan.

A speed control splitter can be used to control more than one fan with a single gauge, see section 1.5.4.

1.5.1 Use Speed Control Knob on the fan

Some fans provide a Speed Control Knob on the Fan Top which allows the user to manually control the speed of the fan.

To use the Manual Speed Control Knob

1. Set the fan speed to zero by adjusting the Speed Control Knob as far as it will go, counter clockwise.
2. Turn the Door Fan power on.
3. Slowly adjust the knob clock-wise, to accelerate the fan.



Figure 6: Speed Control Knobs on the Fan Tops of Door Fans. The Speed Control Knob of the 2350 Door Fan is displayed on the left, and of the 1000 Door Fan on the right.

1.5.2. Control fan speed with a DM-2 gauge

To control the fan speed with a DM-2

1. Connect the included Speed Control Cable from the Fan Top to the port on the back of the DM-2 (labeled “Speed Control”). The cable provided by Retrotec is specially wired to prevent interference between the fan and gauge, but if unavailable, any standard CAT5 or CAT6, Ethernet-style cable can be used.
1. Some fans have more than one speed control port on the Fan Top. In these cases, additional Speed Control Cables can be used to link multiple fans together, with the primary fan being connected to the DM-2. This will allow one gauge to control the fan speed of all fans in a chain, called “daisy-chaining the fans”.
2. If the battery power is too low, connect the DM-2 power cable (in the Umbilical) from the power outlet on the Fan Top to the power input on the gauge. Some model fans do not have this option, in which case the DM-2 would have to be connected to a power outlet using the provided power adaptor.

1.5.3. Use a Manual Speed Control accessory

The Manual Speed Control accessory allows the speed of a fan to be controlled by turning a knob/dial which can be located a distance away from the fan itself.

To use the Manual Speed Control accessory

1. Ensure the power switch of the Manual Speed Control accessory is in the off position to prevent an accidental startup of the fan. Adjust the speed control knob as far as it will go, counter clock-wise, so that the fan is set at zero speed.
2. Attach the Manual Speed Control accessory to the fan using the yellow CAT5, Ethernet-style Speed Control Cable.
3. Turn on the power on the Manual Speed Control accessory.
4. Slowly adjust the dial clockwise to accelerate the fan.
5. The on/off switch can now be used to turn the fan on/off while maintaining exactly the same Set Speed.



Figure 7: Manual Speed Control accessory (Part number CU200)

Older, pre 2005 systems

A Manual Speed Control accessory used to be included with all high-power 3000 Series fan systems but since 2012 a speed control knob has been included on the Speed Control/Drive unit making it of little value to have a separate control

All 'E' and 'R' model systems required the Manual Speed Control accessory to adjust the fan's speed. Older 'Q' model systems include the Manual Speed Control accessory as an alternative method of regulating fan speed. The newest 'Q' model fans have a Manual Speed Control Knob incorporated into the Fan Top, and therefore do not come with an extra Manual Speed Control accessory.

Note: The Manual Speed Control accessory included with older 'Q' model systems connects to the fan using a Speed Control Cable, and will not function with an 'E' or 'R' model system (which uses a DU210 or 2100 model fan).

1.5.4. Use a Speed Control Splitter to control multiple fans

A Speed Control Splitter is used to allow a single gauge to control the fan speed of multiple fans. This is a useful tool when trying to test very large, open, enclosures. Testing time can be significantly reduced by simplifying fan speed adjustment. It also means that automatic control to a test pressure is still possible, even with multiple fans.

The Speed Control Splitter connects to the gauge with the included Speed Control Cable. Additional lengths of Control Cable are used to connect up to seven fans to the Speed Control Splitter. It does not matter which Control Port the fans or gauge are connected to on the Speed Control Splitter.

Model 1000 fans or fans using the 2350 Fan Top include a second Control Port on the Fan Top, which can be used to link multiple fans together, and eliminates the need for the Speed Control Splitter in some circumstances.



Figure 8: Do NOT use this older Speed Control Splitter with a computer connected to the gauges since the interconnectivity may cause damage to your computer. (Part number FN242) works in some configurations. See the Multi-Fan Manual for instructions.

While the gauge connected to the Speed Control Splitter will control the fan speed of all connected fans, it can only measure the Fan Pressure from one fan.

Flow and/or Fan Pressure will still need to be measured simultaneously from each fan to get accurate airflow results. Do not add the measured Fan Pressure from each fan. Instead, convert the Fan Pressure to CFM (flow) (or adjust the gauge to display Flow in CFM), then add the numbers for flow together.



Figure 9: Current Speed Control Splitter (Part number FN280) works in all configurations.

1.5.4.1. Control multiple fans using one primary gauge

Set up the Door Fans and digital gauges according to Figure 10 and the following procedure.

Controlling multiple Door Fans using a Speed Control Splitter

1. Set up Door Fans in doorway(s)
2. Connect Drives to Door Fans using the Drives' Umbilical
3. Connect yellow and green tubes from the gauge to each Drive
4. Connect Control Cables from each Drive to the Speed Control Splitter (Model: FN280)
5. Connect a Control Cable from the Speed Control Splitter to one gauge ("Primary Gauge")
6. T-connect the red tubing from each of the gauges together
7. T-connect the blue tubing from each of the gauges together
8. Pass the red tube through the port in the panel and toss away from the Door Fans' airstream
9. Use [Set Speed] or [Set Pressure] function on the Primary Gauge to control the same speed on all Door Fans

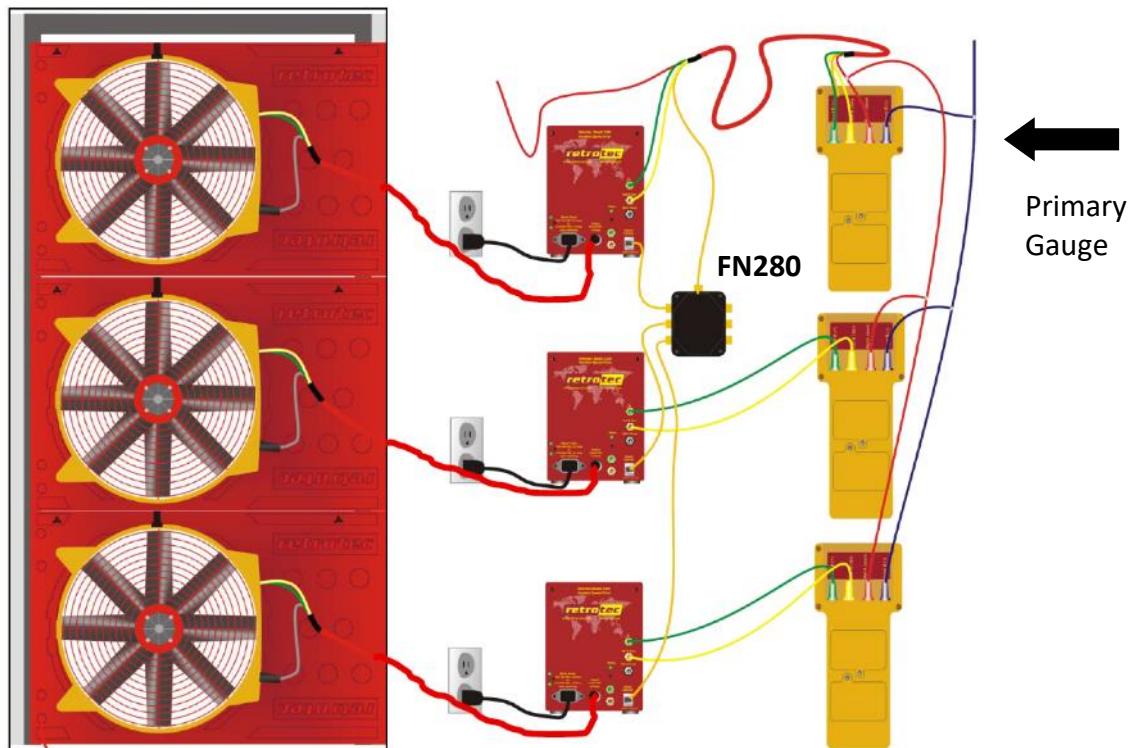

Figure 10: Controlling multiple Door Fans using a Speed Control Splitter with a primary gauge

1.5.4.2. Control multiple fans automatically with gauge and FanTestic software

Set up the Door Fans and gauges according to Figure 11.

The setup is similar to the procedure in Figure 10 except control cables are required from each gauge to the PC running FanTestic software. For DM32, the control connection can be via Wired Ethernet or WiFi, for the DM-2 the control connection can only be via USB.

1. Go to <http://retrotec.com> to download and install a free trial version of FanTestic Pro 24
2. If using a DM-2, install the DM-2 Device Driver from the Retrotec website:
3. Connect the primary gauge to the Speed Control Splitter via Control cable
4. Connect each gauge to a computer (with FanTestic Pro software installed)
5. Start FanTestic Pro, create a new test, Find Gauges, and perform an Auto-Test:
6. For detailed instructions on how to run an Auto-Test, please refer to FanTestic Manuals on Retrotec's website
7. Retrotec also features many step-by-step instructional videos on how to run automatic Door Fan tests with FanTestic, which can be found on YouTube: <http://www.youtube.com/playlist?list=PL303DEAF9DDCF4036&feature=plcp>

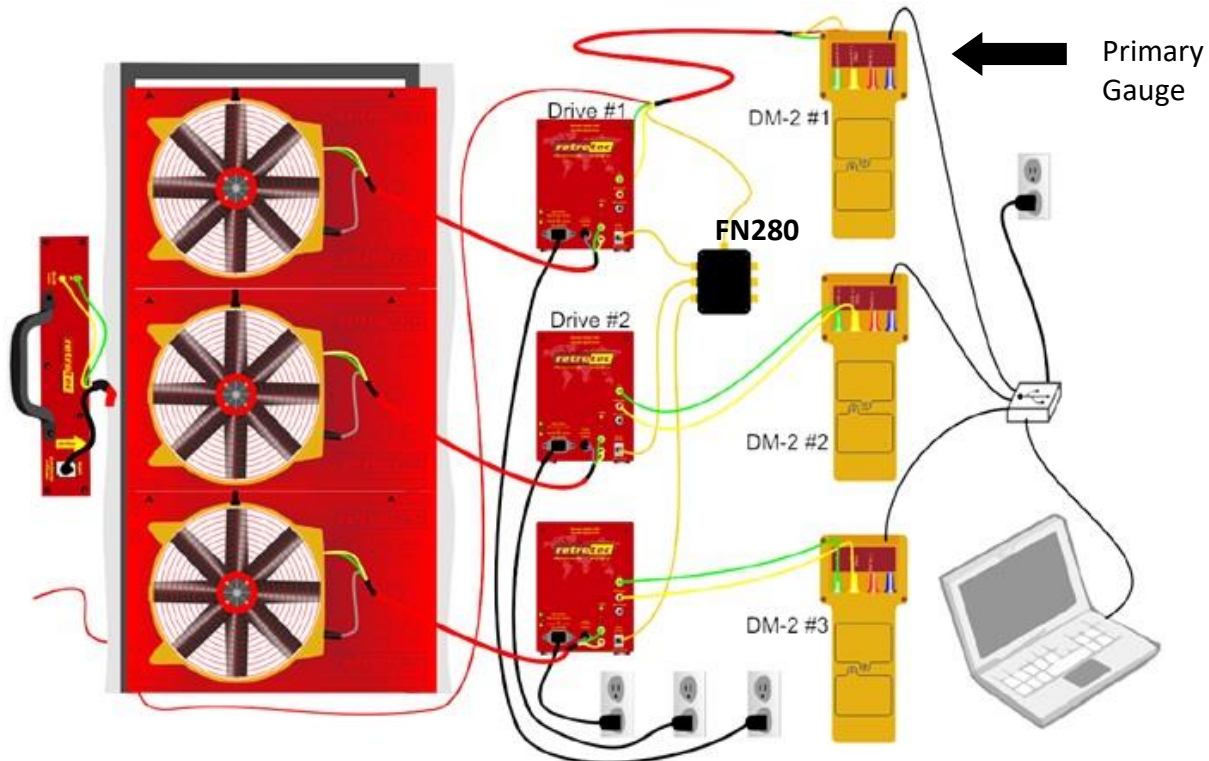

Figure 11: Controlling multiple Door Fans using a Speed Control Splitter with FanTestic Software

2. Choose a calibrated fan suited to your application

Retrotec has a number of calibrated fans designed to operate under different conditions and with different features suited to the various applications.

2.1 Model 1000 for testing homes

The 1000 model fan is a basic $\frac{3}{4}$ horsepower fan with built in speed control and dual Control Ports. Multiple fans can be daisy chained together, and simultaneously controlled by a single DM-2 Digital Pressure Gauge. Speed can be controlled via the DM-2, or manually controlled with the knob on the Fan Top.

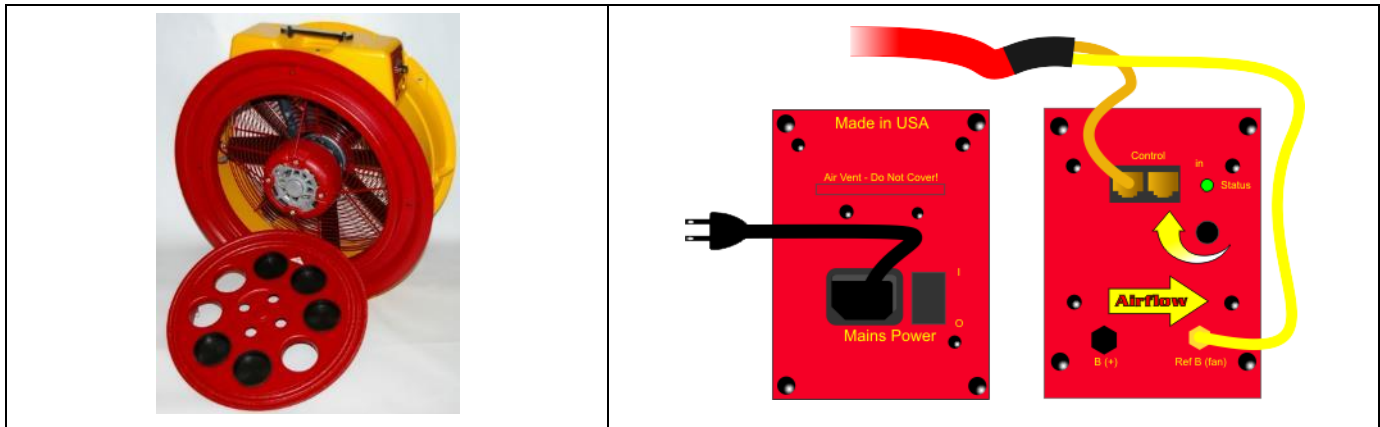

Figure 12: Model 1000 fan with two electrical plates containing power connection and switch, dual Control Ports and manual speed knob.

To connect the 1000 to the DM-2 Digital Pressure Gauge

1. Connect the power cord from the fan to a compatible wall outlet.
2. Connect one end of the yellow tube from the Umbilical to the yellow port on the fan labeled “Ref B” and the other end to the yellow port on the gauge labeled “Ref B (-)”.
3. Connect the Speed Control Cable from the DM-2 “Speed Control” port to the left “Control” Port on the fan.

2.2 Models 3300 and 3300SR high flow fans

The 3300 and 3300SR fans are 2 horsepower fans suitable for residential and commercial testing. The fans are fully automatic and can be controlled through the DM-2. They include a variable speed drive which is the red box containing a 3-phase power supply. The 3300SR fan has an additional green reference pressure port: SR stands for self-referencing.

A self-referenced fan is able to compensate for when the fan is blowing air towards the gauge (and fan operator). Normally a correction to the Fan Pressure is made in the DM-2, but with an SR fan, this correction is not required. See section 1.1 for a detailed explanation of self-referencing.

It is important when using an SR fan to choose the correct Device in the DM-2: 3000SR.

The 3300 and 3300SR fans are not designed to operate on GFCI protected circuits. Doing so may cause the circuit breaker to trip. Ensure that a dedicated 20A circuit is available for each fan. Stove top electrical outlets are an ideal 20A circuit to which to connect the 3300(SR) fans. Do not operate multiple 3300 or 3300SR fans on the same circuit, since each fan at maximum speed can draw up to 20.4A. Do not operate other loads on the same circuit as the fans during the test.

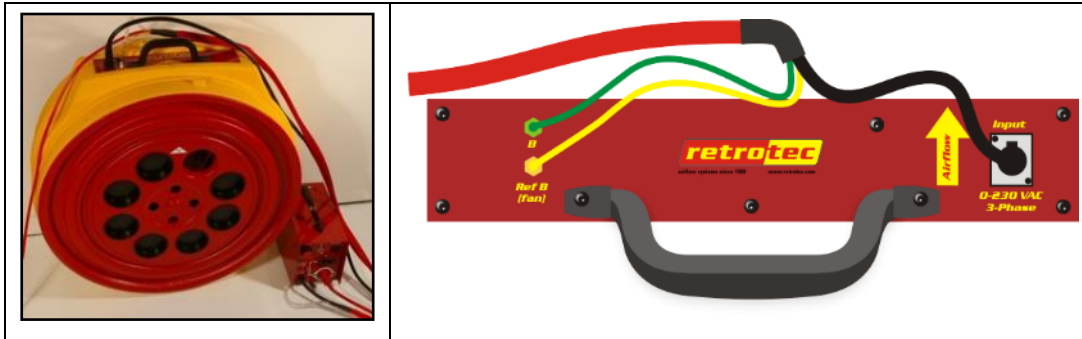

Figure 13: Model 3300 fan and Fan Top (Fan Top shows the 3300SR model).

To connect the 3300(SR) to the DM-2 Digital Pressure Gauge

1. Connect Speed Control Cable from the DM-2 umbilical to the Control Port on the variable speed drive (red box containing power supply).
2. Connect the pressure tubes from the DM-2 umbilical to the matching-color ports on the variable speed drive (some drives do not have color-coded ports – in these cases, attach using pressure port naming conventions on the DM-2). If the variable speed drive does not have pressure ports, connect the color-coded tubes to the matching colored tubes on the Fan umbilical.
3. Connect the power cord from the variable speed drive to a 20A compatible wall outlet. The 3300 fan draws a significant amount of power; no other devices can be running on the same circuit.
4. Connect a pressure tube from the “Ref B” (yellow) port on the variable speed drive to the “Ref B (-)” (yellow) port on the DM-2.
5. If available, connect a second pressure tube from the “Input B” port (green) on the variable speed drive to the “Input B (+)” (green) port of the DM-2.
6. Connect the Speed Control Cable from the umbilical to the “Speed Control” port on the DM-2.

2.3 Model 200 (DucTester) or 300 fans for tight houses

To turn a duct testing system (DU200, DE200, DK200) into a Door Fan system for testing tight enclosures (US200, EU200, and UK200), you only need to add an Aluminum Frame and a Low-Flow Cloth Door Panel.



<p>The Model 200 blower door system has the 0.25 HP 200 fan, which can move between 7 and 725 CFM. It is the predecessor of the Model 300.</p>		<p>The Model 300 is ideal for testing tight houses as large as a 1600 square feet of floor area that leak as much as 3 Air changes per Hour.</p>	
--	--	--	--

If using a 200 fan and a DM32 gauge, you must choose the device called 200 on the Retrotec Blower Doors screen of the gauge so that the correct n value is used in the calculation of @Pressure in the gauge.

The Retrotec 300 fan is recommended for testing tight enclosures. The 300 fan is not available on the DM-2 gauge. On the DM32 gauge, you must choose the device called 300 on the Retrotec Blower Doors screen so that the correct n value is used in the calculation of @Pressure in the gauge.

The hookup can be the same as the Model 1000 as long as the fan is blowing away from the operator as it would be for depressurizing from inside the enclosure. When the fan is blowing Towards the operator, the green port between the fan and gauge MUST also be connected to reference the fan properly otherwise the flow will read extremely high. To avoid any issues, it is recommended that both the yellow and green tubes are connected at all times between the gauge and the fan. Door Fan systems for testing tight enclosures should be set up as shown in Figure 14 below.

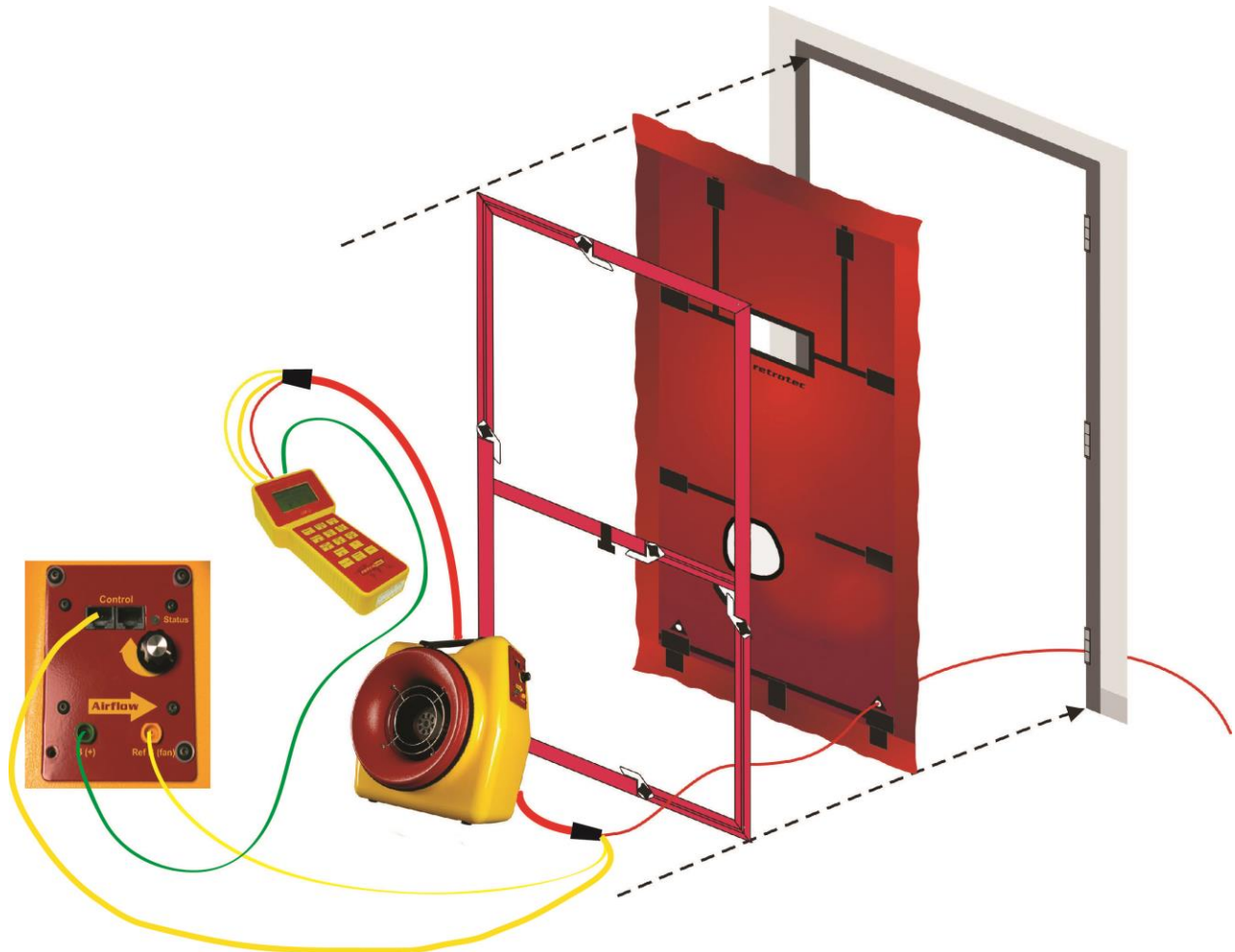

Figure 14: Door Fan setup using a Model 200 fan to test tight enclosures. The left image shows the Fan Top from a side view of the Model 200 fan with tubing and Control Cable connections.

Note: The green tube Must be connected if the flow is towards the operator (i.e. air is blowing towards where the operator is standing), and is recommended to be connected at all times so the correct Fan Pressure is used in all calculations under all circumstances.

The Speed Control Cable can be plugged into either one of the two Control ports on the fan.

For Door Fan testing, refer to procedures outlined in section 4.

2.4 Model 2350 for multiple fan applications

Retrotec's design goal in developing the 2350 Fan Top was to solve several problems that all air leakage measurement equipment manufacturers struggle with:

Unstable voltage, which causes the fan to change speed even though the speed control signal has not changed.

Non-linear control, which causes the initial part of the control to have very little effect, the middle part of the control to have a rapid effect, and the top part of the control to have again to little effect. This 'S' shaped curve response seriously undermines a traditional fan's performance.

Noisy output, which can cause excessive heating in $\frac{3}{4}$ horsepower fans.

In addition to overcoming these shortcomings, unique features such as onboard speed control and daisy chain inputs (which allow any number of fans to be controlled by one gauge), were incorporated into the new speed control. The Fan Top can now be reprogrammed using firmware that allows Retrotec to make adjustments in performance, and features as required. All of this development represents a huge advance in the field of air leakage testing.

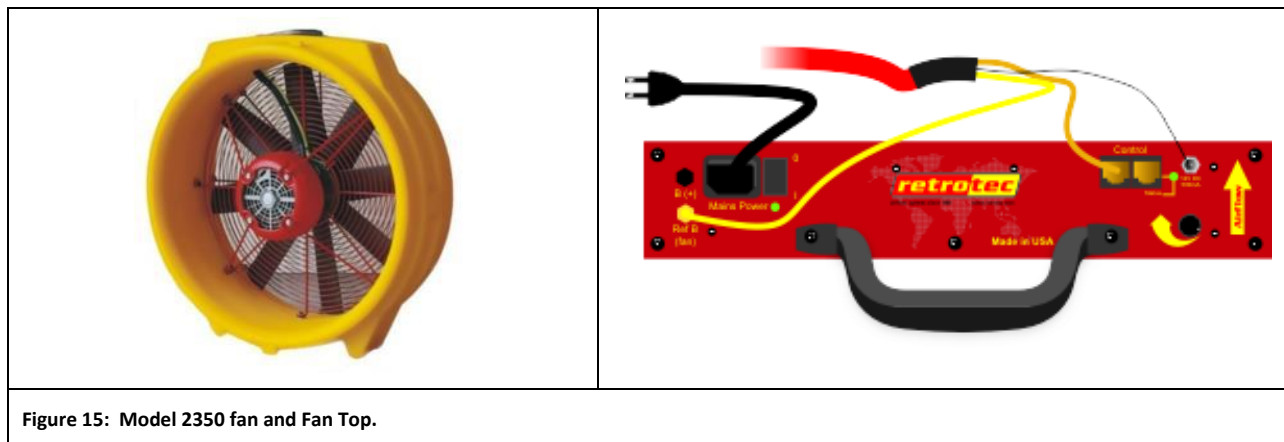

Figure 15: Model 2350 fan and Fan Top.

To connect the 2350 to the DM-2 Digital Pressure Gauge

1. Set the fan speed control knob as low as it will go (counter clock-wise), and power switch in the off position.
2. Connect the power cord from the fan to a compatible wall outlet.
3. Connect a pressure tube from the "Ref B" (yellow) port on the Fan Top to the "Ref B" (yellow) port on the DM-2.
4. Connect the Speed Control Cable from the DM-2 "Speed Control" port to a Control Port on the fan.
5. Connect another 2350 fan by connecting a standard Ethernet-style cable from a Control Port of one fan to a Control Port on the second.

2.5 Model 2100 fans (no longer available)



Figure 16: Model 2100 fan and Fan Top (no longer available).

The 2100 was Retrotec's original 2000 model fan used in the System Model R43. It is a ¾ horsepower fan, suitable for most residential testing. It requires a manual speed control to adjust the fan speed.

To connect the 2100 to the DM-2 Digital Pressure Gauge

1. Connect the power cord from the fan to a compatible wall outlet.
2. Connect a pressure tube from the “Ref B” (yellow) port on the Fan Top to the “Ref B” (yellow) port on the DM-2.
3. Connect the manual speed control to the Remote port on the fan (new speed controls connect via Speed Control Cables, and are not compatible with the 2100 fan).

2.6 Model 2200 fan (no longer available)

A fully automatic version of the 2100, the 2200 fan can be controlled by the DM-2 automatically, with the Set Speed and Set Pressure functions on the DM-2. If required, an optional manual speed control accessory can be connected via a Speed Control Cable to allow manual control of the fan speed (so that the gauge is free to be used for zone or Room Pressure testing).

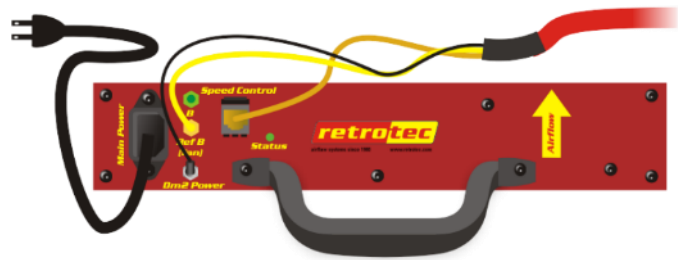

Figure 17: Model 2200 fan and Fan Top (no longer available).

To connect the 2200 to the DM-2 Digital Pressure Gauge

1. Connect the power cord from the fan to a compatible wall outlet.
2. Connect a pressure tube from the “Ref B” (yellow) port on the Fan Top to the “Ref B” (yellow) port on the DM-2.

3. Connect the Control Cable from the DM-2 to the Control Port on the Fan Top.
4. If required, connect a Manual Speed Control to the Control Port on the Fan Top with a Speed Control Cable.

3. Choose a Door Panel based on size of door and fans

Retrotec offers three types of Door Panels. The most common style of Door Panel is a Cloth Door Panel on an Aluminum Frame. Modular panels (or Modular Door Panels) are a set of solid panels that expand to fit most doors, and offer a quick setup or take down option that is professional looking and easy to carry. For large buildings, three fans can be mounted in one Three-Fan Panel, to maximize the airflow pushed through one doorway.

Only 2000 and 3000 Series fans will fit properly in the Hard Modular Panel but they must have a label on the fan stating it will fit properly in the Hard Panel.

3.1 Cloth Door Panel with Aluminum Frame

A Cloth Door Panel with aluminum frame is standard with the Q46, Q56, and 1000 Door Fan systems. If purchased separately, the Cloth Door Panel can be used with most Retrotec fans.

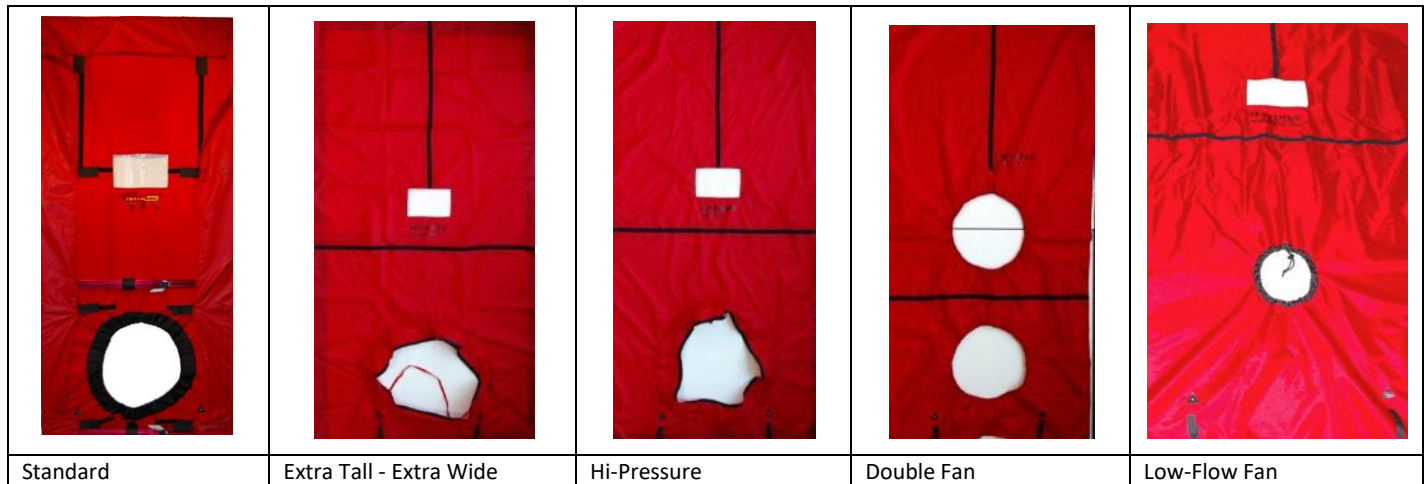

Figure 18: Cloth Door Panel types

Retrotec's aluminum frame comes with a Standard Cloth Door Panel, which can fill a door up to 41.5 inches wide by 95 inches high. However, some applications may require that a different Cloth Door Panel be used with the aluminum frame.

Larger doorways will require the Aluminum Frame Extender Kit, and an Extra Tall Extra Wide Cloth Door Panel. With the extension kit and panel, the maximum door frame width is extended to 48in and the maximum height becomes 110in.

Extender kits increase the size of doorway that can be fit with the aluminum frame. An extender kit consists of vertical and horizontal extenders, a crossbar extender, plus an additional crossbar (#6 Upper crossbar, and extender). Also included is the Extra Tall, Extra Wide Cloth Door Panel.

Table 1: Aluminum frame door panel dimensions.

Dimensions		With Extender Kit
Panel width	29.5 - 41.5 in (75 - 105.4 cm)	30 - 48 in (76 - 122 cm)
Panel height	51.5 - 95 in (131 - 241 cm)	60 - 105 in (152 - 267 cm)
Frame thickness	1.75 in (5.3 cm)	
Frame case	53 x 10 x 4 in (134 x 25 x 10 cm)	
Frame weight	14.2 lbs (6.4 kg)	

A Hi-Pressure Cloth Door Panel is required if testing is expected to exceed 150 Pa (rated for tests at pressures up to 300 Pa). The Hi-Pressure cloth includes additional security straps to hold the fan in place. Adding an additional crossbar is also recommended for high-pressure tests.

Two fans can also be mounted in a single aluminum frame with the addition of a second crossbar and a Double Fan Cloth Door Panel.

A Low-Flow Fan Cloth Door Panel is used to test tight enclosures with a Model 200 fan.

3.1.1. Using the Aluminum Frame

The Retrotec Aluminum Frame is quick and easy to assemble. The ends of each piece are numbered; match the numbers to connect each piece build the frame.

The frame consists of the following parts:

- 1 - #2/3 right side piece
- 1 - #1/4 left side piece
- 1 - #1/2 top end piece
- 1 - #3/4 bottom end piece
- 1 - #5 Lower crossbar with fan strap

Each piece has a black rubber knob which, when loosened, permits the piece to be adjusted in length. The white plastic, tightening Cam Lever expands the frame a small amount, to provide a tight fit when in the doorway.

To assemble the Aluminum Frame

1. Attach the frame pieces so that the matching numbers are aligned. The small metal button may need to be depressed slightly to slide the pieces in. The button should pop back out into the matching hole when the frame pieces are correctly aligned.
2. Flip all of the white cam levers to the off position (flat against the channel).
3. Install the #5 Lower crossbar into the side pieces at the location stamped "5".
4. Place the frame in a doorjamb, with the black rubber knobs exposed. Loosen the black knobs to allow height adjustment of the frame, and raise the top of the frame (while holding the lower part down with a foot) until it is in contact with the upper inside of the jamb. Tighten both side knobs.
5. Loosen all the horizontal adjustment knobs (on the top and bottom and crossbar frame pieces) and adjust frame width until it is in contact all along both sides of the doorjamb. Now tighten the horizontal knobs.
6. Remove the frame from the doorway.
7. Put the cloth cover on the frame. Put the bottom of nylon cover around the bottom of the frame and connect the Velcro strips. Bring the nylon cover up and around the top of the frame and connect the top Velcro strips. Wrap the panel around the side, and connect the final Velcro straps.

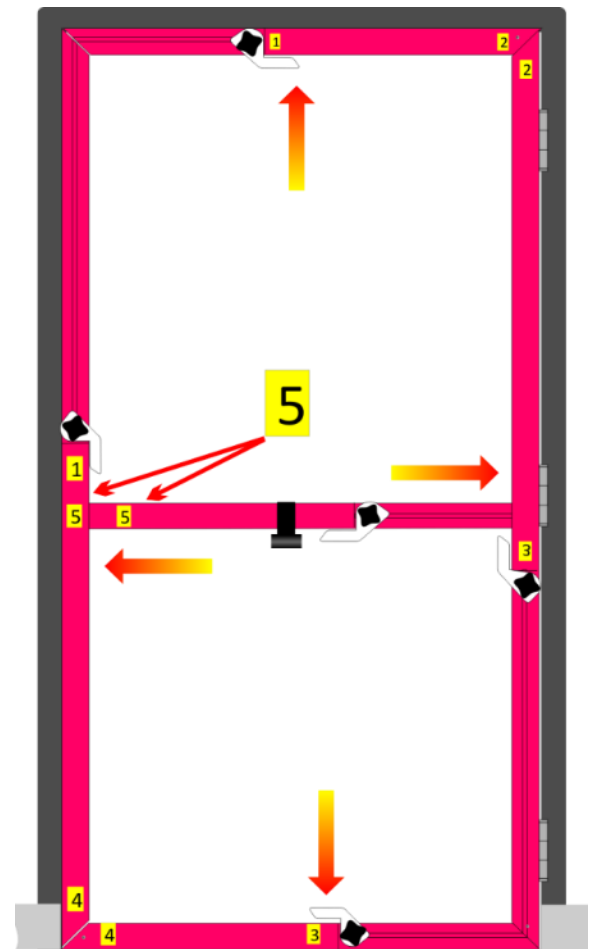

Figure 19: Aluminum Frame for the cloth fan door panel.

- Put the covered frame back in the door opening. Turn all five of the white plastic cam levers to the “expand” position (away from side of channel) to lock it into place.
- Ensure that the panel is solidly anchored in position. If it needs to be tighter, release the cam levers one at a time, loosen the knob, push the frame into position, tighten the knob, and re-actuate the cam lever.

To remove the frame

- Release all five white cam levers. Pull the frame from the doorway. It may be necessary to loosen some of the black knobs if the frame was secured tightly in the doorway.
- Lay the frame flat on the ground, and lean it against a wall.
- Remove the cloth, and fold it for easy packing.
- Loosen the black knobs and collapse the frame to its smallest size. The frame can be transported in this fashion, partially assembled, by re-tightening all of the knobs.
- To disconnect the frame, push the metal button in while pulling the frame pieces apart.

To install the frame extender pieces

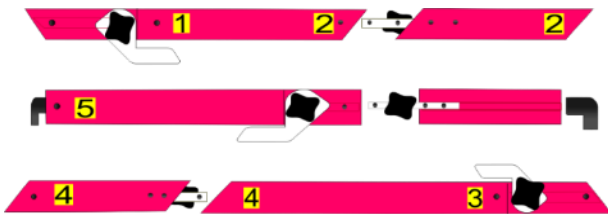

Figure 21: Aluminum Frame extender pieces.

- The horizontal extenders can be attached to the top and bottom pieces of the Aluminum Frame.
- Attach the crossbar extender as well.
- To install the vertical extenders, first remove the corner pieces from the top ends of the vertical frame pieces.
- Attach the vertical extenders where the corners were removed.
- Re-attach the corner pieces to the top of the now longer vertical pieces.
- Re-assemble the frame as described in the previous steps.

To install a fan in the Cloth Door Panel

- Determine which direction the air is required to flow, and align the fan according to the airflow indicator on the Fan Top panel. Airflow into an enclosure pressurizes the enclosure, and airflow out of an enclosure depressurizes.
- Hook the bottom of the fan into the cloth fan hole.
- Guide the elastic ring of the fan hole around the fan casing. The elastic around the fan hole can be tightened, if required, on some versions of the Cloth Door Panel. A tight fit is required to prevent air leakage.

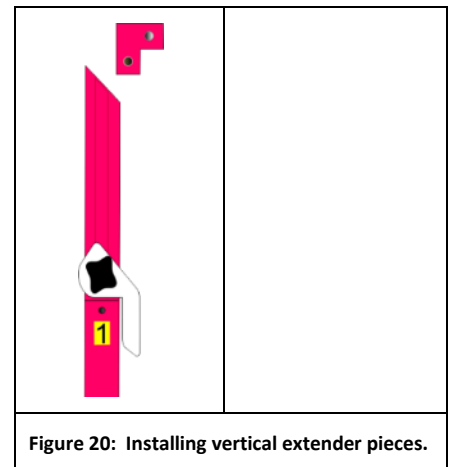

Figure 20: Installing vertical extender pieces.

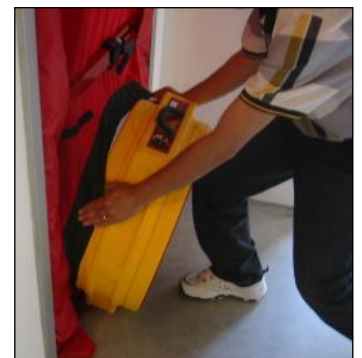

Figure 22: Installing a fan in the cloth door panel.

4. Use the Velcro fan strap on the horizontal crossbar to hold the fan in place. The elastic should not be supporting the weight of the fan.
5. Double-check that the fan airflow is in the correct direction. It will be much harder to switch the fan around once all of the equipment has been connected.

3.1.2. Available Aluminum Frame Part Replacements

It is possible to replace damaged or broken parts of the Aluminum Frame. The following pieces can be replaced:

- Cam Levers
- Knob
- Channel Guides
- Corner Block
- Expander Block
- Weather Strip (rubber part around outside edge)

To order replacement parts, reference the part number in Appendix C.

3.2 Modular Hard Sided Door Panels

A Modular Door Panel is standard with two Door Fan systems: models Q56 and Q5E (see Appendix E for conversion of the old model names to the new ones). If purchased separately, the Modular Door Panel can be used with most Retrotec 2000 and 3300 fans. A special adaptor plate is also available to incorporate Retrotec’s low-flow (DucTester) fans for use with the modular panel.

The modular panel consists of the following parts:

- 1 only Fan Panel with fan strap
- 1 only Large-X panel
- 1 only XY panel
- 2 only Fan Panel fill sheets (one large, one small)



Figure 23: Modular door panel set.

Additional panels, including a Small-X panel, can be purchased to increase the maximum doorway height that the modular panel is capable of filling.

Overall outside dimensions (OD) for the Modular panels:

Model:	PN201
Type of Panel:	Hard Panel (Single Fan)
Width (min/max):	32" – 48.75" (81 - 124 cm)
Height (min/max):	76.5" - 87" (194 - 221 cm)

Panel Case (included):

31" x 30" x 7" (79 x 76 x 18 cm)

PN210R Large X-Panel: 27 ¾"H x 29 5/8"W closed, 51"W open

PN211 XY Panel: 19 ½"H x 29 5/8"W closed, 52"W x 30" open

PN207 Large Fill-in Sheet for Fan Panel: 27"H x 17 ½"W OD

PN208 Small Fill-in Sheet for Fan Panel: 26"H x 4 ½"W OD

A Field Verification Plate and a Blanking Plate are available for insertion in the holes of the Modular Door Panel, to run a verification of the calibration of the system and cover any non-needed holes in Fan Panels. See details in Appendix C.

A Weather Strip replacement kit is also available.

3.2.1. Modular Door Panel Instructions

For detailed instructions on installing the Modular Door Panel, see the *Modular Door Panel Quick Guide*.

To install the Modular Door Panels

1. Unpack the panels. The Fan Panel is installed first. Place it in the doorway, touching the ground. All panels should expand towards the door hinges. The panels can be expanded by pulling the yellow cords tight, and then securing the cord on the cleat. Do not secure the yellow cords on the Velcro, to hold the straps tight. The Velcro is only meant to hold the straps against the panels. Attach the fan strap.
2. Attach a Fan Panel fill sheet to cover any gap that is created by expanding the Fan Panel.
3. Install the Large-X panel, so that it is touching the top of the door frame. Expand it so that it is held in place securely.
4. If required, install a Small-X panel just below the Large-X panel.
5. Install the XY panel. Expand it both vertically and horizontally to completely seal the doorway.
6. Grill mask can be used to seal any small gaps that remain.
7. A second Fan Panel can be substituted for the Large-X panel if required. However, it should be placed directly above the first Fan Panel, with the Small-X or XY panel being used at the top of the doorway instead.



Figure 24: Modular door panel set installed.

To install a fan in a Modular Door Panel

1. Determine which direction of airflow is required and align the fan according to the airflow indicator on the top Fan Panel. Airflow into an enclosure pressurizes the enclosure, and airflow out of an enclosure depressurizes.
2. Insert the bottom of the fan into the Fan Panel.
3. Align the notches on the fan with the corresponding notches on the Fan Panel.
4. Push the fan into the hole, and rotate the fan slightly to secure it in the panel.
5. Hook the fan strap over the edge of the fan shell to hold it in place.
6. Double-check that the fan airflow is in the correct direction. It will be much harder to switch the fan around once all of the equipment has been connected.



Figure 25: Installing a fan in a modular door panel set.

3.3 Triple-Fan Molded Panel Set for multiple fan tests

The Triple-Fan Molded Panel Set is a specially designed folding panel which supports up to three 3000 Retrotec fans in one doorway. The panel is included with the QMG system, or can be ordered separately. Blanking plates are included with the Molded Panel Set, so that it can be used with fewer than three fans if required.

3.3.1. Using the Triple-Fan Molded Panel Set

For detailed instructions on using the Triple-Fan Molded Panel Set, see the *QMG Quick Guide*.

To install the Triple-Fan Molded Panel:

1. Unfold the panel, and lock the four butterfly latches.
2. Place the Fan Panel against the doorway, on the opposite side of the door frame from the door.
3. Secure the top corner of the panel, nearest the hinges, by placing the circular retention strap anchor behind the door/door frame gap.
4. Slide two retention straps over each cross brace, and insert the narrow end of the cross braces into the door/door frame gap, so that it runs parallel to the fold joints of the Three Fan Panel. Secure the cross braces to the Door Panel using the retention straps. The locking collars should be used to keep the retention straps from sliding around the cross braces.
5. Use the corner brace to secure the remaining top corner, by placing it diagonally across the door frame, and attaching a retention strap to the Door Panel.
6. Attach a fan strap for each fan being used.
7. Use grill mask to seal any gap left between the top of the panel and the door frame.



Figure 26: Lock and butterfly latch for the triple-fan moulded panel set.



Figure 27: Cross brace for the triple-fan moulded panel set.

Space permitting, two of the Three-Fan Panels can be joined together to mount six fans together. Use the connector plate to connect the two panels, with the fan holes oriented towards the middle. In this situation, it is unlikely that the cross braces can be used. Use the retention straps and secure the panels using the door/door frame gap where possible.

3.4 Compensating for Panel leakage

Modular Panels are designed to be placed into doors that are not well sealed. The panel leakage for the Modular Panel is about 14 square inches compared to about 3 square inches for the Aluminum Frame and Cloth and around 1 square inch of leakage for the upgraded Aluminum Frame with snap together corners. These three panels represent three typical doorways: a) Poorly weather-stripped which would have an approximate 1/16 inch gap which equals about 14 square inches leakage; b) A well weather-stripped and adjusted door would be around 3 square inches or leakage; c) A super tight door could be as tight as 1 square inch of leakage and can even have less.

One rule of thumb is that all standards require the blower door panel to be leakier and never tighter than the existing door. The Modular Panel qualifies here. It is likely that the Aluminum Frame and Cloth are tighter than the existing door. In either case, if the door panel leakage is 10% of the total, then further investigation is needed.

Panel leakage will vary from one installation to another as will the door leakage.

If you want to make an adjustment to a test result, make these measurements at your reference pressure.

Install the panel in a doorway where the door can be closed with the door fan panel in place, then measure the leakage. This is the Test Panel Leakage + Door Leakage.

Now, tape over the door so it does not leak at all and re-measure the leakage. This is the Test Panel Leakage.

Subtract 2 from 1. This is the Door Leakage.

Subtract #2 and add #3 to your test result.

Modular Panels:

1000 CFM at 50 Pa, no attention needs to be paid to the door panel leakage. If the flow rate is under that you might want to measure the panel tightness compared to the door tightness and subtract any excess from the readings. Or, if the panel is tighter than the door, you will have to add it.

Example; 500 CFM at 50 Pa for the enclosure. Door is closed over top of the panel with the red tube in the gap and leakage measured at 50 Pa of 140 CFM. The door is then taped shut to measure panel leakage which is 80 CFM at 50 Pa. The Door thus leaks $140-80=60$ CFM. Correction to test result is then: $500-80+60= 480$ CFM.

Aluminum Frame and Cloth:

220 CFM at 50 Pa, no attention needs to be paid to the door panel leakage.

Aluminum Frame with upgraded snap together corners and Cloth:

70 CFM at 50 Pa, no attention needs to be paid to the door panel leakage. If the flow rate is under that you should measure the panel tightness compared to the door tightness and subtract any excess from the readings. Or, if the panel is tighter than the door, you will have to add it which is more common and shown in the following example:

Example: 50 CFM at 50 Pa for the enclosure. Door is closed over top of the panel with the red tube in the gap and leakage measured at 50 Pa of 8 CFM. The door is then taped shut to measure panel leakage which is 3 CFM at 50 Pa. The Door then leaks $8-3= 5$ CFM. Correction to test result is thus: $50-3+5= 52$ CFM.

These tests are rarely done but testers should learn how leaky their panels are in advance of any test they may do. Retrotec has performed this test in nuclear power plants where every part of the test needed to be documented including panel leaks. Learning how much your panels leak will be a useful tool to determine how they might be affecting your results. For example, when Modular Panels are used to measure flows well in excess of 2000 CFM, the panel leakage is irrelevant, but in tight rooms it could make the difference between pass or fail. One has to determine then if the door leakage may be a major part of the total and cannot just be deducted. Similarly, if you are using the new tight Aluminum Frame with square snap together corners, your readings might be low.

3.5 Installing panels in double doorways

To install the Aluminum Frame or Hard Panel in a double doorway, follow these steps:

Secure one of the doors in the closed position using the door closures that push pins below and above the door. Run tape around the top of the door face to the opposite side and then up to the door frame on both sides. Run tape around the bottom of the door face onto the floor on both sides. At the bottom of the door, drive solid door wedges in from both sides. All this is to ensure the closed door does not open when the door panel is installed.

Tape strips on the closed door to act as a temporary door stop and to prevent the panel from sliding away from the stationary door.

Install the Door Panel in the open doorway. Test the Frame's stability by pushing and pulling on the frame to ensure it's secure before mounting the fans. Retighten the expansion mechanism as needed for maximum grip.

As added security, install a strap or line from the fan to the top of the doorway just in case the frame falls out to prevent damage to the upper fan(s).

4. Conduct a Test

4.1 Observe house to avoid problems during testing

4.1.1. Ashes and other materials can blow into house

Depressurizing a house causes air to be sucked in from openings. This can be especially troublesome in a fireplace. If proper care isn't taken to cover exposed, loose ashes, prior to beginning a test, the air flowing in through the chimney can blow ashes out of the fireplace.

Likewise, other loose household materials can be moved around by airflow, especially if the materials are located close to a major leak or the fan itself. It's very easy to blow loose papers, and other small objects around a house if due care isn't taken to secure them before beginning testing.

4.1.2. Doors can slam shut

If a door suddenly shuts while using a Door Fan, the sudden change in pressure can be enough to damage an enclosure or pop the fan out of the panel. Be sure to secure doors in the correct position, prior to starting the fan. If a door shuts during testing, and it goes unnoticed, the accuracy of the test will be affected, because not all of the building will be included in the test, as the area behind the closed door is treated as unconditioned space.

4.2 Select a Location

The first step in any test is to select a doorway, and install the Door Panel.

An exterior doorway in a large open room is best. Avoid doorways that have walls, stairs, or other obstructions nearby. These will restrict airflow, and can lead to inaccurate results.

If the exterior doorway opens to an enclosed porch, garage or other area, open doors or windows to ensure the enclosed area is open to the outside.

4.3 Where to place the exterior Pressure pickup tube(s)

The exterior pressure reference for the differential pressure measurement across the door panel is provided by the red tube. The exterior pickup location must be chosen to minimize the influence of wind, sun and atmospheric pressure on the differential measurement, or measurements must be taken to allow correction for these influences. Each standard defines what is expected in terms of the exterior reference pressure measurement. Use Table 2 to determine where best to locate your red tube depending on the standard procedure you are following.

Table 2: Locations for Exterior Reference Pressure Pickup as required by the various Standard Procedures

Exterior pressure pick-up locations from Standards	
ASTM	1 tube across the middle of each façade (NOT at corners of the building)
	Manifold and average all pressure readings using a manifold (averaged ver 10s)
	If > 3 stories, measured at more than 1 height
ATTMA	Measured at the lowest floor level of the building
	Located "some distance away" from the building envelope, out of the way of fan airflow and sheltered from wind
CGSB	Calm conditions - 1 pressure measurement outside the building is ok
	Windy - min of 4 measurements on each façade, manifold
	Gusty winds - use wind damping kit (capillary tubes, averaged over 5s)

EN13829- FR	Measure at the bottom floor level, but if tall building, measure at the top as well
	Keep exterior pressure taps out of the sun, and fitted to a T-pipe or connected to a perforated box to protect from wind
USACE	Min 1 exterior pressure tap required, but if bias pressures high, use more
	Interior pressure gauge references tied together in a manifold to read 1 pressure reading

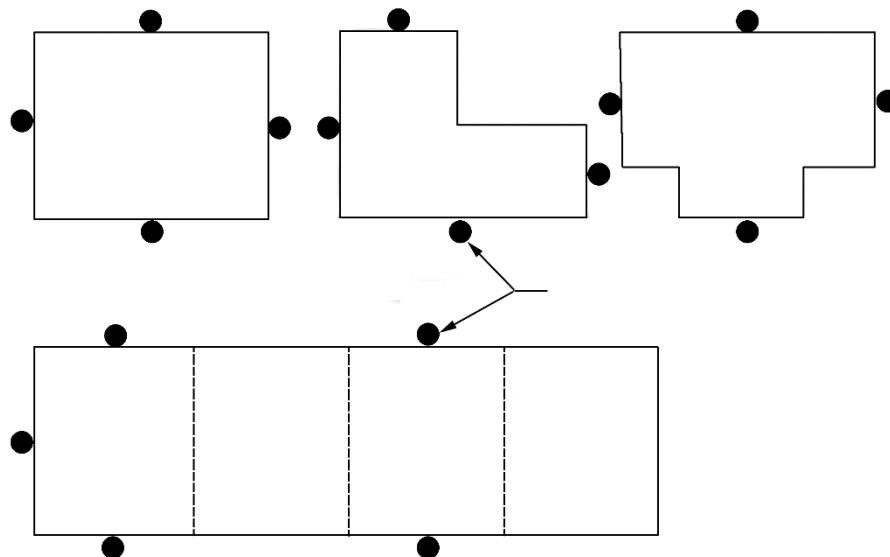

Figure 28 typically recommended locations for exterior pressure pickups

Even though most standards recommend pressure pickup placement as shown above, this is seldom done because the fluctuations are not large enough to warrant the time. In fact, results may be improved by multiple pickups or in some cases may be made worse. Sometimes one exterior pickup is sufficient.

See section 5.8 “**Enclosure pressure measurement disturbances**” for more details on how to avoid pressure fluctuations.

4.4 Determine if corrections for temperature difference are required

In conditions where the interior and exterior temperature differential varies greatly, the fan measurements can be less accurate. In a depressurization test, the Door Fan system measures the fan flow out of the building. However, the measurement is meant to reflect the air infiltrating into the house through all the leaks. When there is a temperature difference, the air density changes, and the leaks will not exactly equal the measured fan flow. In extreme conditions, this difference can be as much as 10%.

Each Standard that users comply with will require different corrections. FanTestic software will manage these corrections when calculating results after you enter the data.

4.5 Install the Door Fan for Depressurization test

1. All Retrotec fans include a yellow “Ref B” port (might be brass on some models of 3300 fans). Connect the yellow pressure tube from “Ref B” on the fan to the yellow port on the gauge, “Ref B (-)”.
1. For most Door Fan tests, a red pressure tube is run through the Door Panel (away from the tester). The other end of the red pressure tube should be connected to the red pressure port on the gauge.
2. Some model fans will include a self-referencing port (green). Connect the green tube from the port marked “B” on the fan (usually green), to the green port on the gauge.
3. If available, a blue pressure tube can be connected to the blue port on the gauge, for some types of testing.

The green reference port is available on self-referencing fans (3000SR and DU220). When this port is present on the fan, connect a green tube from the green port on the Fan Top to the green port on the gauge. The green tube connection will ensure that results are accurate, regardless of the direction of the fan's airflow. A Self-Referencing fan is not affected by airflow that is directed towards the operator, whereas non-self-referenced fans are affected.

When the airflow is directed towards the operator, non-self-referenced fans need to have Fan Pressure measurements corrected for back pressure before air flow results can be calculated. Ensure that the correct Device is chosen on the gauge so the gauge can determine if a correction needs to be applied.

Reference the specific test procedure for more information on which connections need to be made to set up for specific tests.

To control the fan speed with a DM-2

1. Connect the included Speed Control Cable from the Fan Top to the control port on the top of the gauge. If the original yellow Speed Control Cable provided by Retrotec is unavailable, any standard CAT5, Ethernet-style cable can be used, but users may experience interference between the fan and the gauge.
1. Additional Speed Control Cables can be used to link multiple fans together, with the primary fan being connected to the gauge. This will allow one gauge to control the fan speed of all fans in a chain.
2. If the battery power is too low, connect the DM-2 power cable (usually included in the Umbilical) from the fan to the gauge. Some fan models do not have this option. If not available, plug the DM-2 power adaptor into the wall. The DM32 must be powered from an adapter in the wall, or can be plugged into a USB port on a computer.

4.8 Select the correct Range configuration

All Retrotec fans have multiple Range configurations. The Range configurations are used to affect the airflow and fan pressure through the fan. During testing, it is necessary to select the correct Range Configuration to achieve measurable and accurate results.

Each Retrotec DucTester includes three ranges, and each Door Fan comes with 11 Range Configurations for the greatest possible accuracy and versatility.

Selecting a Range configuration is based upon the air flow that is required to achieve the test pressure in the enclosure. A general rule of thumb is to select a Range configuration so that the Fan Pressure is twice (or more) the desired test pressure in the enclosure.

Testing should always be done with the most restrictive Range Configuration on the fan as possible for the following reasons:

1. Accuracy increases as Fan Pressure increases
2. High Fan Pressure results in high fan speed, which aids in cooling the fan

3. When conducting multi-point tests, starting with a restrictive Range Configuration eliminates the need to change the Range Configuration during the test.

Note: In European countries where a 50 Hz power system is used, Range Configuration selection becomes more critical because the fans will run 20% slower. Therefore, there is not as much difference between minimum and maximum flow on any given Range Configuration.

4.9 Determine which Range to use on a Door Fan

1. Attach Range Ring A and B.
2. Set the gauge to Range Configuration B
3. Adjust the fan speed until the desired Room Pressure is reached.

If using the DM-2 digital gauge:

4. If "TOO LOW" is shown on Channel B of the DM-2, attach the C8 Range Plate. Restrict the flow further, until the gauge is able to measure a pressure.
5. Press **[Range Config]** until the correct "Range Config" is displayed on the DM-2 screen.

Or

4. If the desired Room Pressure cannot be reached, take Range Plates or Range Rings off.
5. Press **[Range Config]** until the correct "Range Config" is displayed on the DM-2 screen.

If using analog gauges:

4. Select a Range Configuration so that the Fan Pressure is twice (or more) the Room Pressure.

4.10 Cannot reach required pressure?

If the enclosure to be measured has an excessive amount of leakage, to the point where a single fan unit on the Open Range and at maximum speed, cannot reach the required pressure, try one of the following solutions:

1. Use a second (additional) fan to produce more flow. The combined flow readings can be used to get the total amount of airflow required to achieve the induced pressure. Do not add Fan Pressure readings (PrB), they are not cumulative. Fan Pressure must be converted to flow in CFM (or some other units) and then the resulting flows can be added together.
2. Test at the highest pressure that can be reached, and use the @ Pressure key to extrapolate what the flow would be at the desired pressure. Check that the Standard you have to comply with allows this.
3. Seal leaks prior to testing. This can include ensuring that all dampers, windows, and doors are closed, in addition to sealing leaks and holes. This may reduce the leakage enough that the desired test pressure can be reached.

4.11 Choose either a Single or Multi- Point Test Procedure

There are two common Door Fan test procedures available for testing the air leakage of a building: a single-point test, and a multi-point test.

A single-point test establishes a 50 Pa test pressure in the building; results come from measuring the fan flow required to maintain the pressure imbalance. This is a quick and simple way of measuring airtightness, and by using the Fan Pressure measurement, simple results such as the size of the total leakage can be determined.

A multi-point test requires that the user collect flow data for several different induced target pressure points.

4.12 Taking Manual Single Point Readings

This section is written for circumstances where results are read directly from the gauge. They may possibly be recorded manually also but not necessarily.

4.12.1. Measure the Baseline Pressure before turning the fan on

Commonly, test procedures require that the pre-existing pressure across the building be measured and that value be subtracted from the test pressure to uncover how much change occurred in the building pressure due to Test Fan operation. Baseline is sometimes called Bias Pressure or even Static Pressure but we will primarily use “Baseline” here.

The length of time to take the Baseline varies from Standard to Standard or the amount of time needed may not be mentioned. Ten seconds is a reasonable amount of time to spend on Baseline Capture on a calm day but as the wind increases or the Baseline fluctuates at all, this should be increased. To determine the effects of wind, set your gauge to 1 second averaging and if the pressure fluctuation is above 1 Pa, take the Baseline for 30 seconds. If the pressure fluctuation is above 2 Pa, take the Baseline for 120 seconds. If the fluctuation is still above 1 Pa after 120 seconds, continue to acquire the Baseline until the average fluctuates less than 1 Pa.

Save this Baseline once you are satisfied with it. The value stored and displayed on your gauge will be deducted from all future readings so make sure you eliminate the stored Baseline before running your gauge in another application.

4.12.2. Adjust your test fan manually

Adjust the Blower Door (also called Test Fan or Door Fan) fan speed manually using the control knob to the required test pressure that will often be 50 Pa. Change the Range if you cannot achieve the test pressure or if no flow reading appears on Channel B. With the gauge still set to a Time Averaging of 1 second, you may take a reading but chances are you’ll be over or under the required test pressure or the result will fluctuate on either side. To get the exact reading at your test pressure, enter Set Pressure, 50 Pa for example, then press the “@” Key to get results at exactly 50 Pa.

To get an even more accurate result and with the fan still running set the Time Averaging to the same amount of time taken to Capture the Baseline. Channel B will stay blank while the average is being taken after which the result will be displayed. If the fan does not continue to run during this step, and the longer Time Averaging is set, then you must wait until the fan comes up to speed, then wait the time for the Averaging before taking a reading because the gauge will be averaging for the entire time and will be averaging in values below the test pressure. As a rule of thumb, always wait double the Time Average setting before taking readings.

On the DM32, tap Channel A to activate the Hold feature so the readings don’t change while you’re writing them down.

4.12.3. Adjust your test fan using Set Pressure

Warning: using this automated procedure will allow the fan to run up to full speed should a door be opened during the test, causing damage when it is closed. If in doubt, use the previous method.

With the gauge still set to a Time Averaging of 1 second, enter Set Pressure, 50 Pa for example. Change the Range if you cannot achieve the test pressure or if no flow reading appears on Channel B. Once you get within 10% of your desired test pressure, press the “@” Key to get results at exactly 50 Pa and with the fan still running set the Time Averaging to the same amount of time taken to Capture the Baseline. The display will go blank for that same time period after which you can read your result off the display and change units without affecting the readings. You can also HOLD the display, shut the fan down and change units.

4.13 Taking Manual Multi-Point Readings for FanTestic Software

In general, the multi-point test requires that the user collect pressures for a pre-test baseline, collect flows for a set of target pressures (in one or both pressurize and depressurize directions), and sometimes to collect pressures afterwards for a post-test baseline. The collected data is entered into software such as FanTestic in order to generate results from the test which indicate the amount of leakage in the tested enclosure.

Each Standard that users comply with for collecting the data and generating the results have different sets of target pressures (based on different required maximum and minimum target pressures and number of different targets), different requirements for the baseline measurements, and different ways of calculating the results.

The method described in this section is recommended to achieve the most accurate and repeatable test results. Skipping or reducing any of the steps may allow your test results to pass, but this does not mean that an accurate test has been performed.

In order to produce the most Retrotec has included factory defaults in FanTestic which recommend the number or baseline and target points for each of its supported standards. Unless these recommendations are followed, tests will not be repeatable and there will not be enough data to determine what went wrong with a particular test. Retrotec will not be able to analyze the test and recommend corrections if these recommendations are not followed.

4.13.1. Decide how many test points to take

Taking an accurate test means that results will be more repeatable. Taking an inaccurate test means that re-tests of the same enclosure may show very different results. Accurate tests results are achieved with more abundant data, taken over a longer time interval. The EN13829 standard, for example, requires only 5 induced target pressure points but this will usually produce non-repeatable results, as the following graphs show.

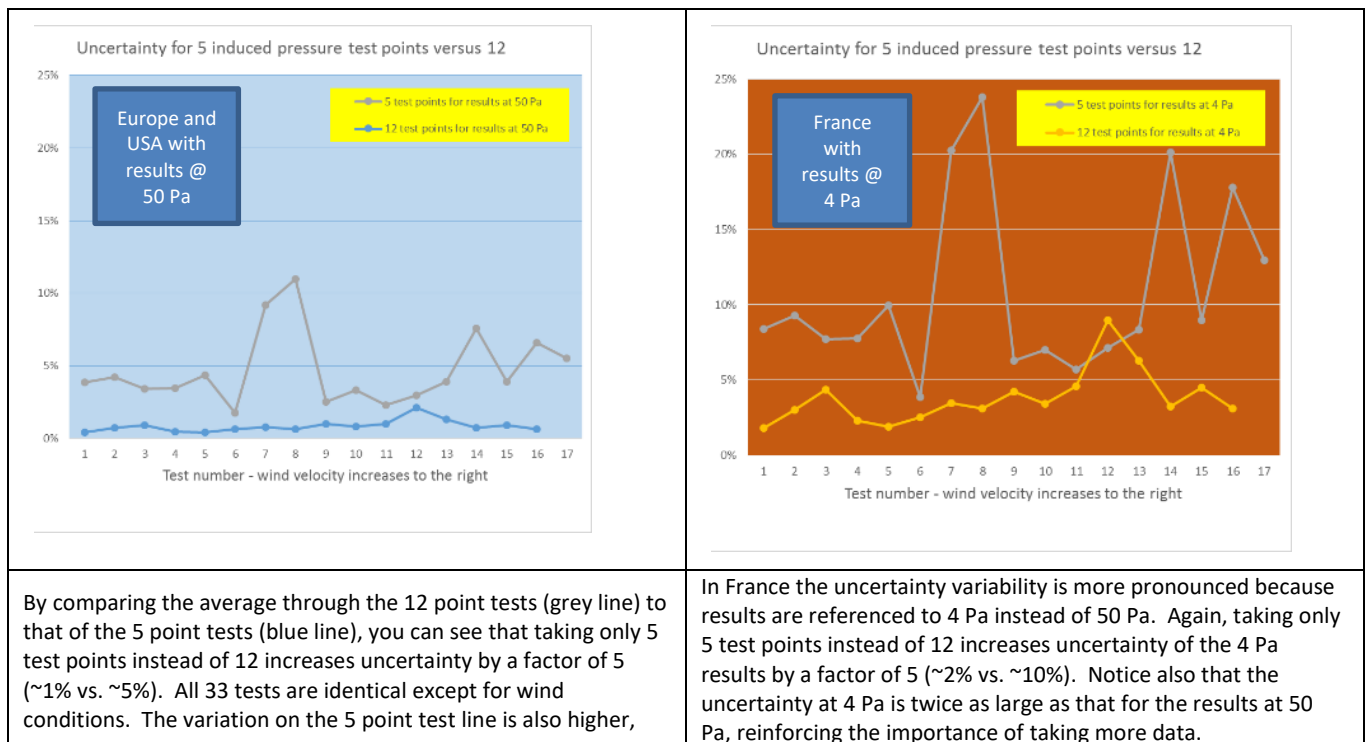

demonstrating the unreliability of taking tests with fewer data points.	
---	--

4.13.2. Decide whether to test in both directions

Testing in both directions means repeating the set of target pressures: placing the fan to exhaust one direction will cause pressurization and in the other direction will cause depressurization.

By testing in both directions, Uncertainty can be reduced further: usually by 50%. The EN13829 Standard states “It is recommended that two sets of measurements are made, for pressurization and depressurization.” Just like testing with only 5 points, you may get passable results occasionally but if there are problems with your test you may be required to repeat it.

As long as the pressure reference for the gauge remains in the same location during the whole test (inside the enclosure or outside the enclosure), a negative sign on one of the sets of target pressure readings and a positive sign on the other set indicates that the sets were taken in different directions. That location is entered in FanTestic as Operator location. The pressure reference for the gauge is the port that is open (blue port if doing a house test because the red port has a tube connected).

4.13.3. Decide what is the optimum opening size on the fan (Range)

Carrying out this step first is another way to ensure a repeatable test; since uncertainty will be lowest if you can collect data for all target points on a single range. If a single range is not possible, try to arrange that there are at least three points taken on the two ranges that you end up using. It is best not to just rely on the software to advise that you’re on the wrong range or you may end up with up to three ranges in a single data set. Using more than one range can change the Uncertainty by up to 2%. It is fastest to start your test on the correct range so you don’t have to use extra time in the middle of collecting data.

Follow this procedure:

1. Determine the highest test pressure you will require during the test, for example 70 Pa. With the fan blowing away from you to depressurize while you are inside the building, increase fan speed using Set Speed or the control knob so pressure on Channel A rises above 70 Pa but not above 80 Pa. If you cannot reach the desired target pressure (70 Pa in this example), change to a more open range to get more flow. Getting more flow means the open area of the fan inlet must be increased so you are not looking for a higher Fan Pressure but a more open fan. If you can easily achieve 70 Pa, try a less open range that will give less air flow and try again.
2. Determine the lowest test pressure you will require during the test, for example, 15 Pa. Leaving the fan as it was at the end of the previous step, running and achieving the maximum pressure with the most restrictive possible range, decrease fan speed using Set Speed or the control knob so pressure on Channel A falls to just below 15 Pa. There will be times you cannot reach the lowest target pressure (15 Pa in this example). Either you cannot run the fan slowly enough (reach 0% speed before the target pressure reaches 15 Pa), or the flow on Channel B will not show a value (not enough fan pressure is being developed). In either case, you need to change to a more restrictive range to develop more fan pressure. Since you already determined the smallest range that will let you reach the maximum target pressure (in step 1), you now know that you will have to change range once during your data collection.

4.13.4. Measure the Baseline (Zero Flow) Pressure before the test

Commonly, test procedures require that the pre-existing pressure across the building be measured. That value is subtracted from the test pressure to uncover how much change occurred in the building pressure due to Test Fan

operation. Baseline is sometimes called Bias Pressure or Zero Flow Pressure or even Static Pressure but we will primarily use “Baseline” here.

Note that there are two main components of Baseline: one is caused by stack pressures and the other by wind. Stack is a building phenomenon which produces a steady pressure and is simply subtracted from the test pressure. Wind may also cause some steady pressure which can be subtracted. However, wind generally also causes a pressure that fluctuates over time. This fluctuation will distort the induced (applied) pressure difference when the Blower Door is collecting data unless the measurement period is long enough to reduce the effect of the fluctuations.

The length of time the Baseline must be taken varies from Standard to Standard but mostly is not specified exactly which is why this guidance is being provided. EN13829 states “over a period of at least 30 seconds” but does not state the required number of test points.

Recommended procedure to take the pre-test Baseline:

When manually entering data into FanTestic, set the Time Averaging on the gauge to 5 seconds for Baseline readings. Start at 5 second averaging for manual readings since it will take you at least this long to write them down anyway. There is a Baseline feature on the gauge but do not use it for this purpose since it was designed for single point readings.

4.13.5. Measure each of the target points required for the test

Use either the fan speed control knob, the gauge Set Speed control, or the gauge Set Pressure control to capture data for each of the target induced pressure points you need for the test.

When manually entering data into FanTestic, set the time averaging on the gauge to at least 20 seconds for induced pressure and flow readings. This must be done in order to compensate for the effects of wind and to ensure that you get an average reading. On windy days you will have to take readings for a longer period of time. To determine if it is windy, set your gauge to 5 second averaging and check if the pressure fluctuation is above 2 Pa. If so, double the time averaging for the induced pressure and flow readings to 40 seconds.

On the DM32, you can tap Channel A to activate the Hold feature so the readings don’t change while you’re writing them down. On the DM-2, press the HOLD key. Write down all your readings.

4.13.5.1. Adjust your test fan using Set Speed

All Retrotec fans have a knob for controlling speed. You used this in the earlier check to ensure that the Range installed on the fan is correct and will allow the fan to pressurize to the desired target pressures. You can use the knob or you can use the Set Speed button on the gauge to get to each target pressure.

To take each target pressure point:

1. Adjust fan speed to your highest target point. Once you get within 10% of your desired test pressure, press the “@” Key to get results at exactly the target pressure
2. Activate the Hold feature so the readings don’t change while you’re writing them down. To activate: On the DM32, tap Channel A; on the DM-2, press the HOLD key.
3. Write down all your readings.
4. Repeat for each required target pressure

4.13.5.2. Adjust your test fan using Set Pressure

You can use the Set Pressure button on the gauge to get to each target pressure. Using set pressure is fastest and most accurate, but heed the following warning.

Warning: *using Set Pressure on the gauge will allow the fan to run up to full speed should a door be opened during the test, possibly causing damage. If in doubt, adjust speeds using the control knob or Set Speed.*

To take each target pressure point:

1. Use Set Pressure on the gauge, and enter the desired target pressure.
2. Observe the flow on Channel B. Change the Range if you cannot achieve the test pressure or if no flow reading appears on Channel B.
3. Once you get within 10% of your desired test pressure, press the "@" Key to get results at exactly 50 Pa.
4. On the DM32, tap Channel A to activate the Hold feature so the readings don't change while you're writing them down. Press the HOLD key on the DM-2.
5. Write down all your readings.
6. Repeat for each required target pressure

4.13.6. Complete taking the data set for this direction

If your standard requires a post-test baseline, follow the steps as you did in section 4.13.4 when capturing the pre-test baseline.

This will complete a single Data Set for this test. Depending on the direction of fan flow, this data set will be either a Pressurization or a Depressurization Data Set.

4.13.7. Take another data set with fan flow in the other direction

Once the Data Set in the first direction is complete, turn the fan around and start again at section 4.13.4. Collect data until you have taken another pre-test Baseline, another set of target points and a post-test Baseline.

4.13.8. Enter collected data into FanTestic to get Results

Once the test is complete, you will have two Data Sets, each containing a pre-test and post-test Baseline and one will contain target points from the Depressurization data set, and the other will contain a pressurization data set.

Enter this data into FanTestic software which will give you the results you need.

When entering data in FanTestic and testing in both directions, you add data for first direction and then you add a "New Set" and enter data from the second direction. Adding a New Set will produce a single test file with both the pressurize and depressurize data in it, and FanTestic will automatically combine the results and produce the summarized data as per your selected Standard. Each standard combines the results somewhat differently. Adding a New Set is more efficient than creating a new test file for each set of data, so you can save time.

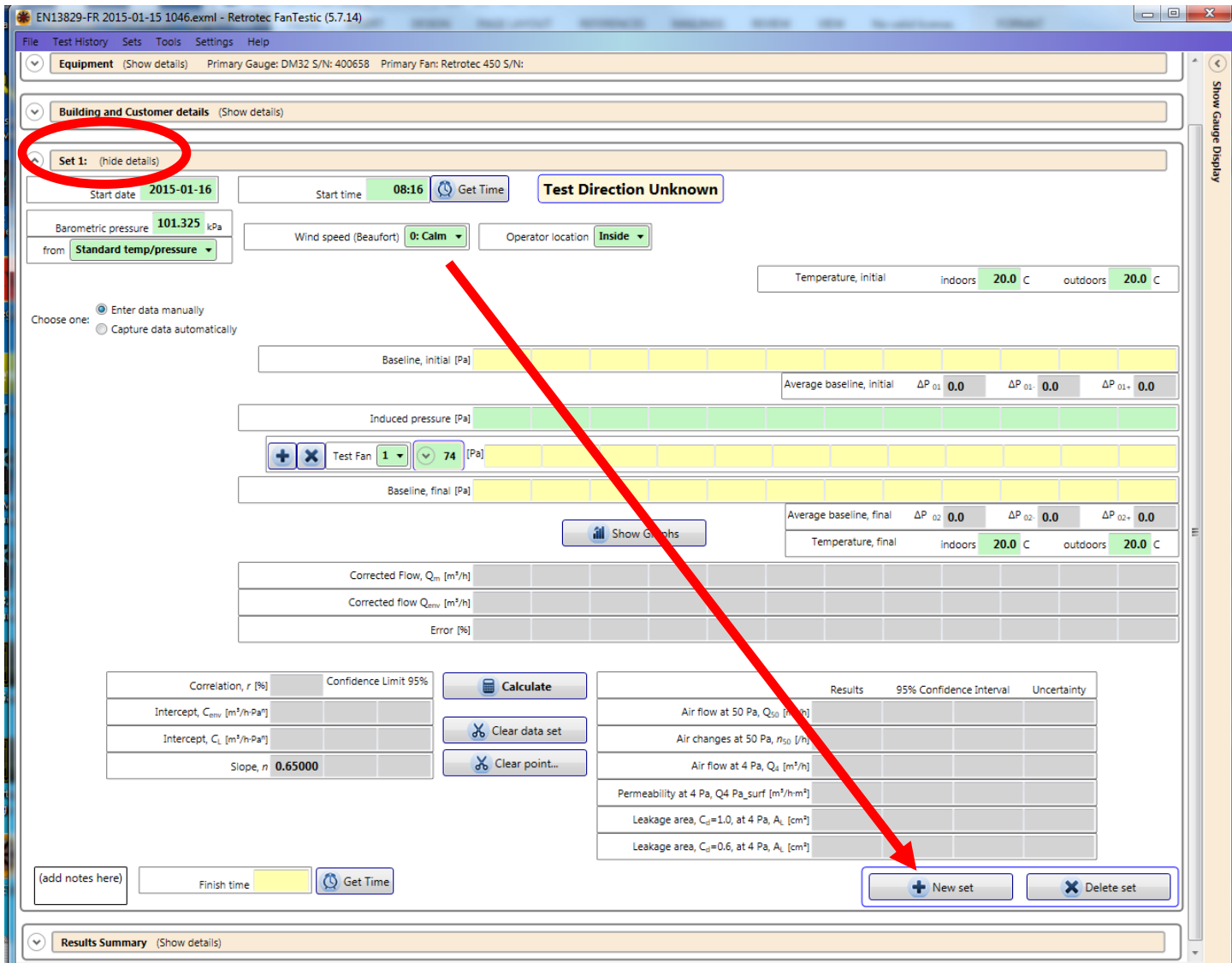

After you add a New Set, there will be two places to add data, one section for each test direction:

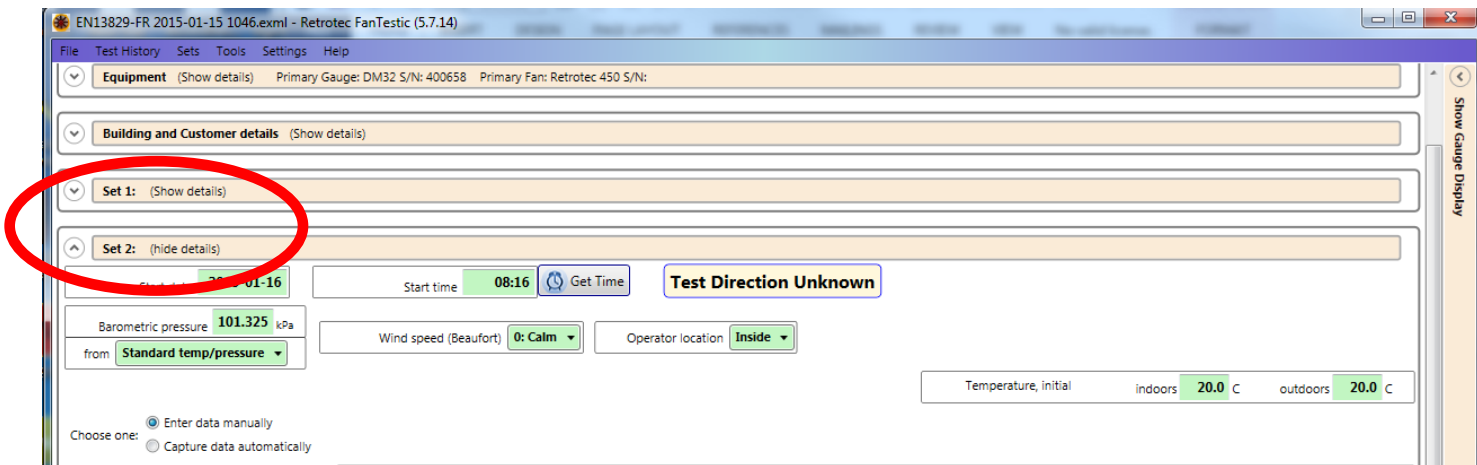

4.14 Completely automated results using FanTestic

You can have FanTestic do all the steps for you but at first, it is wise to follow the preceding manual procedures so you can get a feel for what the software will do for you.

Even if you do use FanTestic to control the test, it is recommended to manually check that the range you have installed on the fan is the optimum one before starting the Automatic test in FanTestic (section 4.13.3).

Ensure FanTestic is set up to test as recommended by Retrotec. Go to the Settings menu, and click “Advanced – view or change default parameters” . In the window that opens, click on “Settings” tab.

Start by clicking on “Reset to Standard Defaults” to be sure your FanTestic has the recommended values. To close this window, use the OK button at the bottom, not the x button in order to be sure your chosen parameters are saved. Only adjust if you have good reason.

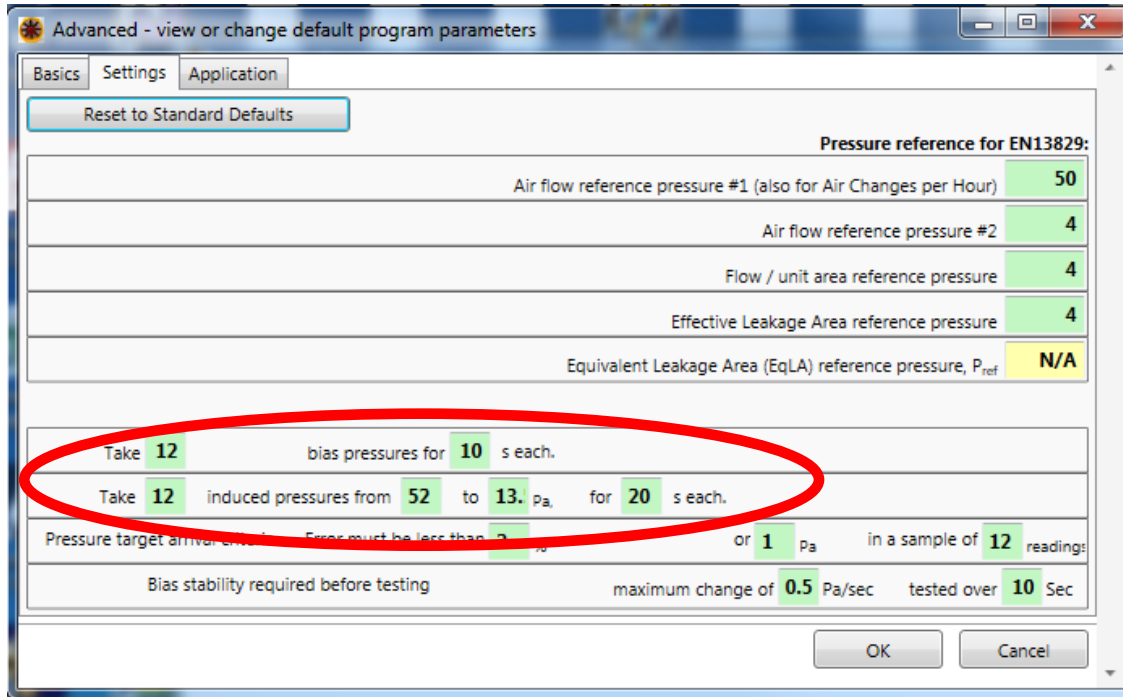

Now FanTestic will run the test for you. Check your FanTestic manual for more details by clicking Help.

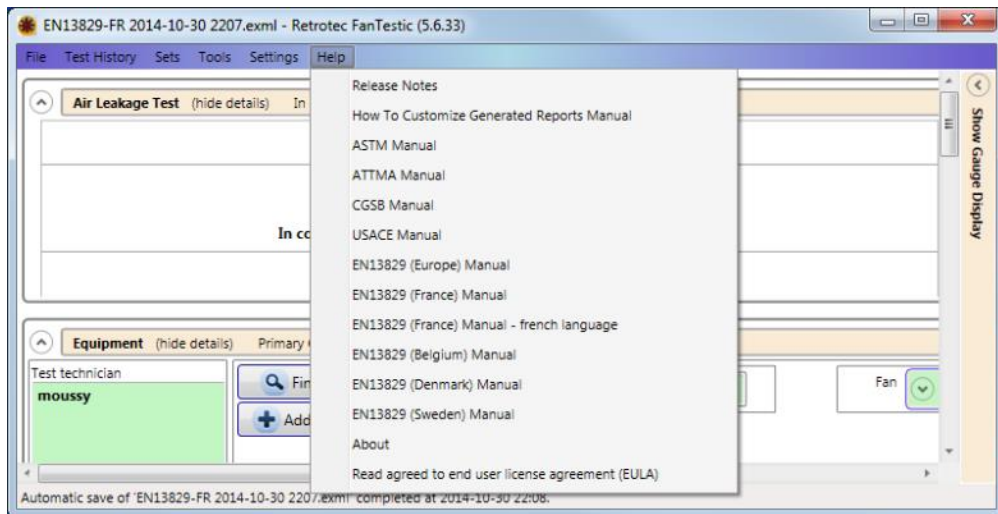

4.15 Basic Results from Single Point Test

Basic test results from a single-point test can be used to provide a simple and quick assessment of a building's airtightness. The DM-2 digital gauge is capable of displaying most common calculations directly on the screen as the measurements are being made.

4.15.1. Air Leakage at 50 Pascal

The industry standard measurement is CFM50. This is the airflow (in cubic feet per minute) required by the Door Fan to create a pressure difference, between the building interior and the outdoors, of 50 Pascals. This difference is roughly equivalent to the pressure that the building experiences in a 20 mph wind.

4.15.2. Air Changes per hour at 50 Pa - ACH50

ACH50 is the number of complete air changes that will occur in one hour, when a building pressure of 50 Pascals is applied across the building envelope. The value is calculated based on the volume of the enclosure, so it is a useful method of normalizing leakage rate.

4.15.3. Equivalent Leakage Area - EqLA 10

Equivalent leakage area is defined as the area of a hole in a thin panel that would leak the same amount of air as the building does at a pressure of 10 Pa with reference to the outdoors. (Discharge coefficient of 0.61)

4.15.4. Effective Leakage Area - EFLA 4

Effective Leakage Area calculation is defined as the area of the elliptical nozzle-shaped hole that would leak the same amount of air as the building does at a pressure of 4 Pa with reference to the outdoors. (Discharge coefficient of 1.0)

4.16 Results from Multi-Point Procedure

Read Retrotec Manuals on FanTestic Software.

5. Avoid Common Sources of Error

Some level of error is unavoidable in all Door Fan testing. However, there are a number of common mistakes that are made that can lead to grossly inaccurate results.

5.1 Wrong Range Configuration or Device

Always make sure that the fan in use, and the Range Configuration that is installed on the fan, is correctly reflected in the settings on the DM-2. Each device, and associated Range Configuration, has a specific calibration. Selecting the incorrect device or Range Configuration will lead to incorrect calculations of airflow and other results.

5.2 No Reference Tube when Pressurizing

When pressurizing an enclosure, the fan is pushing air into the same enclosure in which it is located. It is important to make sure that the fan is referencing the correct pressure.

The DM-2 is capable of self-correcting when the fan flow is towards the fan operator, however, fans with an additional reference port must be connected properly, as the DM-2 will not apply the correction when those devices are selected.

5.3 Incorrect @ Pressure usage

Forgetting that @ Pressure is on can lead to all results being taken at the same pressure. If the flow doesn't appear to be changing when multiple points are being taken at different pressure, check that the @ Pressure function is turned off. Also, if the measurements indicate that the enclosure is far tighter, or leakier than expected, the @ Pressure setting could be converting the results to a vastly different pressure than the desired test pressure.

It is not advisable to use the @ Pressure function when the fan cannot reach a pressure that is even close to the desired pressure reading. This can lead to highly inaccurate results.

5.4 Choose the Appropriate Test Direction

Selecting a test direction is heavily dependent on the type of test being conducted. Consult the specific test procedure to ensure the correct direction is chosen.

All Retrotec fans include an arrow on the Fan Top or control panel to indicate which way the airflow will travel. Use the airflow arrow to determine if the fan is pointed in the correct direction. Buildings often leak exactly the same in both directions but occasionally a small increase in leakage of 5 to 10% may be apparent under pressurization since this test direction can open up flaps over exhaust fans.



Figure 30: Airflow direction arrow on the Fan Top.

5.5 Minimize effects of upstream Air Flow conditions

The calibration for all Door Fans is sensitive to upstream air flow conditions (e.g. orientation of walls, doors, stairs etc..., relative to the fan inlet). This is particularly true when measurements are taken using the Open Range configuration. To minimize problems, follow these rules whenever possible:

1. Install the fan in a doorway leading to a large open room. Avoid installing the fan in a doorway where stairways or other major obstructions to air flow are very close (1-5 feet) to the fan inlet.

2. If the fan must be installed next to a stairway or major obstruction, it is best to take measurements with a Range Ring or Plate installed, and not the Open Range configuration.
3. Open the inside door and outside storm door as much as possible during the Door Fan test to prevent restrictions to air flow.

5.6 Considerations when operating with high backpressure

Note: For most testing applications, backpressure is not a concern and can be ignored.

The term "backpressure" describes the pressure that the Door Fan is working against when it is running. Backpressure is determined by measuring the Baseline pressure difference between the air directly upstream of the fan, and the air directly exiting the fan. Typically, backpressure is simply the test pressure at which the building airtightness measurement is being made (e.g. 50 Pascals). However, in some applications, the Door Fan could experience backpressures that are greater than the test pressure. For example, if the Door Fan is exhausting air into a confined area (such as an attached porch), it is possible that the porch area could become pressurized relative to outside creating a backpressure condition that is greater than the test pressure. Although the Door Fan flow sensor is designed to account for variations in backpressure, certain high-backpressure operating conditions can degrade the calibration of the fan.

Retrotec Door Fans are calibrated to function in testing applications with backpressures up to 80 Pascals, with no significant effect on accuracy. This is true for all Range Configurations (Open through L1), provided that the fan is operated within the accepted Range Configuration. Backpressures above 80 Pa will restrict the available Range Configurations from which accurate results can be obtained. When a Retrotec fan is used with the DM-2, or with Retrotec software, compensation is automatically applied for the backpressure and the flow rate is not displayed when results might be inaccurate.

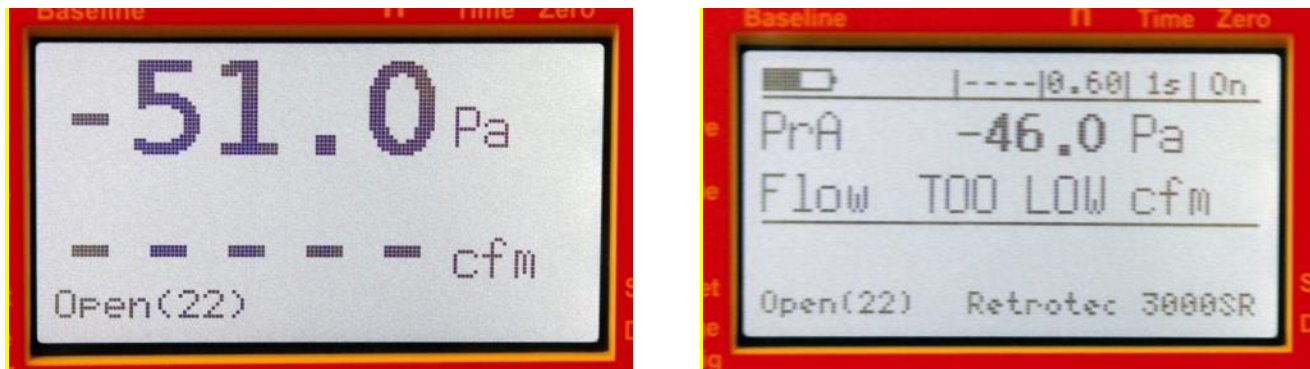

Figure 31: DM-2 can't display flow reading because of back pressure.

5.7 Wind effects on test fan accuracy

Measurements are best taken with the test fans in the downwind or leeward part of the building away from velocity pressures caused by the wind. If that cannot be done and if the wind is significant, say above 5 mph, then considerations should be given to the winds effects.

1. When wind strikes a test fan in a blower door system, the accuracy can be affected for the following reasons:
2. Air striking the pressure pickup will alter the fan pressure reading without changing the flow rated
3. The velocity profile across the fan face will alter the relationship between Fan Pressure and flow
4. Turbulence will be added to the incoming airstream
5. A negative pressure may be created as the air passes the fan at a shallow angle.

It has been noted that test fans can read 5 to 20% high when being struck by wind. Experiment with your fan on a wind free day by testing an enclosure, holding fan speed constant and taking a reading. Then, blow air at your fan at different angles and velocities and note any effects.

When this was demonstrated in the classroom this apparatus was used to demonstrate this effect but an enclosure actually works better. In this case the fan blowing into the flex was set to the same approximate flow rate as the fan at the end with a 50 Pa pressure in the duct. The flow rates were compared. The fan at the end was out of the airstream and could be relied upon to create the same flow rate as long as the pressure in the flex was about the same. Then, the fan at the front had air blown at it at about 15 mph using another test fan to determine if there was an effect. Three different fans were mounted at the inlet of the flex. Two had their flow reading increase by 5% while another increased by 20% with the fan at the end of the duct recording the same flow rate as before. This meant that the air blowing at the fans were causing them to read high.

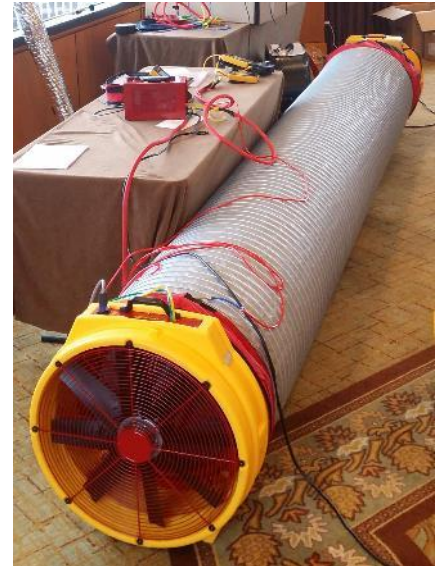

5.8 Enclosure pressure measurement disturbances

Induced enclosure pressures are the difference between outdoors and inside the measured zone. The outdoor pressure pickup point(s) will be affected by wind. Steady winds create pressure that can be subtracted from readings but wind is never steady and it's the fluctuations that cause problems. Generally, on the windward side of the building impacts the ends of pressure tubes creating a positive pressure due to the wind velocity being stopped by the tube. Positive pressures will also result from the overall air movement being stopped by the windward side of the building creating a positive pressure field that can extend 5 to 20 feet from the building. To overcome these effects, it is best to use pickup point(s) away from the direct impact of wind.

The impact of the wind can be best measured by the effect on the gauge. First, extend the exterior pressure pickup point of the tube away from the fan's airstream and about 5 feet from the building. Monitor the gauge for ten minutes. If the gauge reading is above 2 Pa, insert a T in the tube end and cover the tube end with a flat sheet. If still above 2 Pa, T the tube and add two equal length tubes sufficient to be placed in two wind free locations on opposite sides of the building. It may be necessary to T these tubes once more to create 4 pressure pickup points, again with equal length tubes.

Ensure the tube ends are not in contact with water since that will seal them off.

Red tubes are always run through the Door Panel and connected to the Red port on the gauge. If testing from inside the building, red tubes will be run outdoors. If testing from outside the building, a red tube runs through the panel but Blue tubes are used to pick up the outdoor pressure. This is done to ensure, the gauge always reads the pressure in the building with the correct sign, namely, if the building is being depressurized, the gauges will read negative. If pressurized, the gauges will read positive. This works whether the tester and gauges are indoors or outdoors.

Passing more than one tube through the enclosure is possible and an approach that is sometimes used but in general there is seldom an advantage to doing this. As long as the exterior pressure pickup used is in a favorable location, it will adequately represent the outdoor pressure since the outdoor pressure will be unaffected by the test fans since outdoors is an unlimited sink for airflow just like it is when for the grounding of electrical circuits.

Running multiple blue tubes indoors is important because we must ensure all areas in the zone have similar test pressures.

6. Maintain system for optimum operation

Regular ongoing maintenance is an important part of keeping equipment in a usable condition.

Before performing a test, the pressure connections on the fan must be inspected for blockages that can occur due to water or dust. Allowing excessive quantities of gypsum dust to enter the fan will prematurely wear out the bearings and may plug the fan pressure ports, preventing the measurement of pressures and flows. If dust is observed, or the fan has been in an environment high in dust or moisture, use a vacuum cleaner to clear the 4 ports on the fan nacelle of dust and/or water in the places where the tubing attaches to the fan. The nacelle is the housing is mounted upstream from the motor.

Retrotec Door Fans maintain their calibration unless physical damage occurs. Conditions which could cause the fan calibration to change are movement of the motor and blades, relative to the fan housing, damaged flow sensors, and leaks in the sensor or tubing running from the flow sensor to the fan pressure tap.

6.1 Check motor and fan blade position

Fan calibration can change if there has been movement of the motor and blades, relative to the fan housing. Such a damaged condition will be easily apparent if the C8 Range Plate will not sit properly on Range Ring B, or if the motor mount looks bent.

6.2 Check for Flow Sensor leaks

Retrotec calibrated fans use four flow sensors that are mounted inside the plastic housing that goes over the front of the fan.

To test for leaks in the sensor or from the sensor to the fan pressure tap

1. Attach a piece of tubing to the yellow connector on top of the fan. Leave the other end of the tubing open.
2. Find the four small holes located on the red plastic that covers the motor. They should be evenly spaced around the motor, with one on the top, bottom, left, and right. Temporarily seal the four holes by covering them with masking tape.
3. Suck on the open end of the tube, to create a vacuum in the tubing. Cover the end of the tube with your tongue or finger, if the tubing sticks, a vacuum has been created, and the flow sensor does not leak. Make sure that the vacuum persists for at least 5 seconds. If you hear a sound of air moving through the tubing, then there may be a disconnection inside the fan somewhere.
4. Remove the tape from each hole individually, and ensure that air can be sucked through that particular hole. Check each of the four pressure sensing points in turn.



Figure 32: Pressure sensor on the fan motor casing.

6.3 Perform a field verification monthly

A field verification of the fan calibration should be performed approximately monthly. It is a simple way to verify that the equipment is still operating correctly. Some standards such as RESNET require this to be done yearly and for records to be kept. This “check” is not a calibration of any range in particular but does test the pressure pickups to see if they are leaking or blocked because those are the most common problems with the equipment. If one range is reading correctly, there is a good chance the others are also but this does not take the place of a complete calibration which would test the calibrated fan at the top, middle and bottom of each range and

determine the error at each test point. This Complete Calibration is an expensive test to perform because to do it properly requires over \$100,000 in test equipment, (which is why it's expensive). For many applications testing on one range regularly is the best option. If the equipment is out more than 10 to 15%, the equipment should be sent back to the manufacturer for a complete calibration test.

A field verification check on the gauge described in the DM-2 and DM32 manual should be done prior to performing this check.

To perform a field calibration using a doorway

1. Install cardboard with a 20 x 20 inch hole in the upper part of a doorway in a room with all exhaust and supply registers sealed. A square hole is easier to cut accurately compared to a round hole but the round is supposed to work better although we have never noticed much difference.
2. Set Time Averaging to 10s and Press the [@] key until “@50.0 Pa” appears.
3. Perform a Door Fan test on the room and record the EqLA at 50 Pa with the hole open and again with it sealed.
4. Subtract the first result from the second result and the value should be 400 sq in (at least +/-10% and sometimes within 5%). This is about 3100 CFM50 and even though EqLA is used the gauge is merely doing the math to display CFM at area.

The same check can be performed with the field Verification Plate, which can be purchased for the Modular Door Panel system.



Figure 33: Homemade verification plate.

A field calibration can also be performed by using the optional Flex Duct and a field Verification Plate, or a piece of cardboard with a 400 in² hole cut into it.

To perform a field calibration using a Flex Duct

1. Secure the Flex Duct to the outlet side of the fan.
2. Attach a panel to the open end of the Flex Duct with a 400in² (20 in X 20 in) hole cut into it.
3. Run a blue tube from the gauge (blue port) to the panel, and insert it into the Flex Duct.
4. Perform a Door Fan test on the flex duct and record the EqLA at 50 Pa with the hole open and again with it sealed.



Figure 34: Flex Duct attached for calibration check.

7. Power to run the fan and gauge

7.1 Status lights indicate power and control connections are ready to go

Current Retrotec Door Fans have two LED lights on the Fan Top. “Mains Power” indicates the power status next to the AC power input. The second LED, “Status”, indicates status of the connected gauge.

The 3300(SR) series fan includes a three-phase power supply, which contains two power status lights.

Table 3: 3300SR fans mains power – power input monitoring

3300 Series Fans		
100 – 140 VAC, 22 Amp	210 – 260 VAC, 14 Amp	Indication
Solid green	Off	Low voltage input
Solid green	Solid green	High voltage input
2000 Series Fans		
Solid green		Voltage input

The 3300(SR) fan will operate at a reduced efficiency level when connected to a low voltage input. It is safe to use, but may not reach its maximum operating speed.

Table 4: DM-2 status light indications

DM-2 Status Light	Indicates
Blinking red	Lost communication with DM-2
Solid green	Good communication with DM-2
Flashing green	DM-2 not connected or turned off

7.2 Using the Fan with Mains Power

The 3300 and 3300SR fans are not designed to operate on GFCI protected circuits. Doing so may cause the circuit breaker to trip. Do not operate multiple 3300 or 3300SR fans on the same circuit. Stove top electrical outlets are an ideal 20A circuit to which to connect the 3300(SR) fans.

In European countries where a 50 Hz power system is used the fans will run 20% slower.

7.3 Using the Fan with a power generator

Retrotec recommends a generator with inverter type AC power output. Size the generator capacity above the maximum power required in order to reduce distortion of the AC power waveform. The higher the rated power output, the better. Suggestions for minimum generator output sizes are 3000W for Door Fans and 500W for DucTesters.

Table 5: Acceptable generator power output for specific fans.

Fan	Operating Voltage	Max Operating Current (Watts)	Max Inrush Current	Minimum Generator Power Output
3300 - 3 Phase Power supply, double wall fan as found in: QMG, Q4E, Q5E	120VAC	22A (2640W)	Equal due to soft-start ramp-up of inverter.	3000 W
	208VAC	13A (2704W)		
	230VAC	10.5A (2415W)		
	240VAC	10.3A (2472W)		
	120VAC	12 (1440W)	15.5A (1860W)	

2000 Series , double wall fan as found in Q46, Q56	208VAC	6.2A (1290W)	7.6A (1580W)	500 W
2350 , double wall fan as found in Q46, Q56	120VAC	10A (1200W)	23A (2760W)	
	208VAC	4.5A (936W)	10A (2080W)	
1000 Wheel rim style, single layer	120VAC	12A (1440W)	23A (2760W)	
	208VAC	4.8A (998W)	11A (2288W)	
DU200 Series DucTester	120VAC	2A (240W)	2.5A (300 W)	
	208VAC	N/A	N/A	
DU200 w/2350 Fan Top	120VAC	2A (240W)	3A (360W)	
	208VAC	0.9A (187W)	1.2A (250W)	

When selecting the generator, look for key words and phrases including:

“inverter output”

“utility-grade AC power”

“suitable for sensitive electronics”

Table 6: Portable generator AC power output types.

Type of AC Power Output	Comments/Expectation	
Inverter	Best; Compatible	Recommended
AVR – Automatic Voltage Regulation	Questionable; May not perform	Not Recommended
Brushless	Worse; May not perform	Not Recommended
CycloConverter	Worst; May not perform	Not Recommended

7.4 Recommended Generators

7.4.1. Honda Generator EU2000 (120V, 2000W, 67 lbs)

Works will all DucTester fan models.

Works with both 2200 and 2350 series fans.

The Honda EU2000 provides 2000 watts and 120V AC power. It is equipped with an inverter, and is specially designed for sensitive electronic equipment. At 16.7 Amps, it meets the needs of most Retrotec equipment, although it does fall below the recommended minimum power output.



7.4.2. GENYX G3000HI (230V, 3000W) generator

Works with all Retrotec Fans.

The G3000HI is equipped with an inverter, and runs at 230V and a maximum of 3000W.

It meets the minimum requirements for even the most powerful Retrotec equipment.



7.5 Portable Power Supplies for DucTester

Portable power supplies can provide enough power for Retrotec DucTester fans, but are unlikely to produce sufficient power for a Door Fan. Please ensure that the power supply meets the minimum power requirements of the fan before attempting to use one.

7.5.1. Black and Decker Electromate 400 Model VEC026BD

Works with DucTester fans with a 2350 Fan Top.
Do not use with Door Fans, or with DucTesters without a 2350 Fan Top.
The VEC026BD is a 110/120VAC power supply with a built in 400W inverter.



8. Fan Troubleshooting

8.1 Retrotec 2000 series 120 Volt AC motors overheat and shut off

There is a lot of variation from one motor to the next as they come from the manufacturer. Some motors heat up more than others, in spite of undergoing the same manufacturing process. All motors are tested at Retrotec facilities for 1.5 hours under full current and stress. The motors which shut off due to excess heat are rejected, and sent back to the beginning of the production line. Some users, however, may still encounter problems in the field. Below are some points that may be followed to remedy a specific problem.

Make sure the motor runs as close to full speed as possible. The faster it runs, the more air goes through the motor. A rule of thumb is to have the Fan Pressure over 100 Pa and the motor running near full speed. The motor heats up the most at $\frac{3}{4}$ -speed where it draws 13 amps at 120 volts. At full speed the motor will draw less current!

Make sure the C8 Range Plate has the cooling ports in line with the ones on the motor cover. If the mounting indicator sign is in the correct position, this will ensure the ports are fully open.

Ensure that the switch on the speed controller is in the off (0) position at the rocker switch, not just turned down. If left on low speed with the blade not turning, the controller and the motor will be stressed.

The thermal breakers that shut down the motor are not adjustable. To learn when maximum heat is created, put a current meter on the fan, and adjust the fan speed to see when it is pulling maximum current, and therefore creating maximum heat.

More current = more heat.

More airflow through motor = less heat.

A more drastic solution is to change the blade or to cut a quarter inch off the blade tips and re-balance the blade to reduce the load on the motor.

8.2 3300 High Power Fan will not control smoothly

Retrotec 3300 series variable-frequency fans require 100-280 VAC 50/60 Hz power in order to operate reliably. Voltage drops due to line losses and fluctuations in AC power can be significant. The fans will not work at line voltages of less than 95 VAC.

If the system will:

1. Not control smoothly
2. Slow suddenly
3. Stop completely
4. Produce less than 6,500CFM @100% speed
5. Multi-fan systems will oscillate, with fans running at varying speeds

The problem is likely that insufficient line voltage is arriving at the variable-frequency power supply.

To resolve the lack of smooth control issue

1. Use a 240VAC Stove or Dryer outlet or
2. Use 208VAC or
3. Reduce extension cord length on 120V circuits and/or use an industrial quality 12 gauge extension wire.

8.3 3300 Fan will not start

The 3300 series fan's variable speed drive (power supply) will stop working if either of the following conditions occurs:

1. The internal 25 Amp circuit breaker is triggered
2. The internal relay comes loose

If either situation occurs, disconnect the supply power cord from the wall outlet.

To reset the power supply's circuit breaker

Ensure that the drive is unplugged from any external power source. The circuit breaker can be located without removing the cover of the power supply. Look through the holes on the right side of the power supply. The white button is located at the top left of the right side panel. Check whether it is popped open (upward). It can be reset without removing the case by using a paper clip.

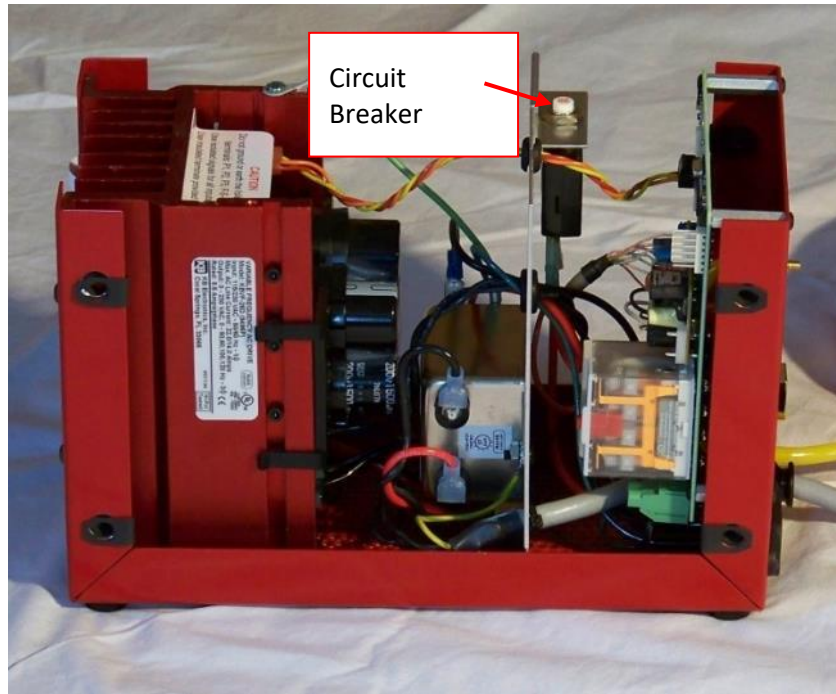

Figure 35: Reset the variable speed drive power supply with the circuit breaker.

To ensure the relay hasn't come loose

If you shake the power supply slightly, you should be able to determine if the relay has come loose. Look through the holes on the left side of the power supply. The relay is located at the bottom right of the left side panel. The relay is enclosed in a clear plastic box.

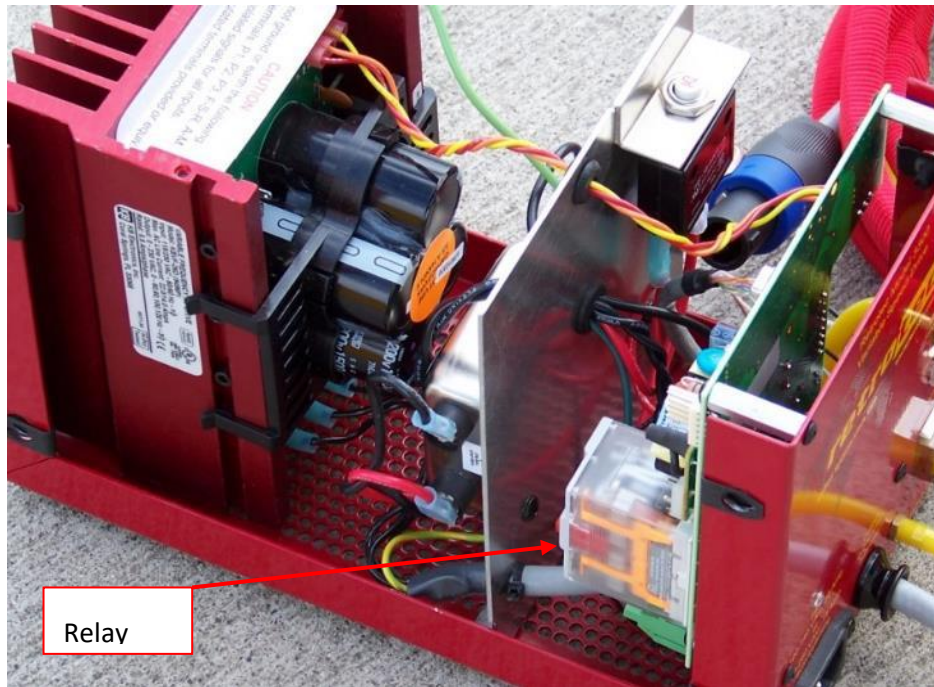

Figure 36: Relay box in the variable speed drive.

Ensure that the relay is seated properly. The relay may require gluing with silicon glue. The case cover screws will need to be removed in order to access the relay. Remove the tamper seal, if so equipped. Remove the front left side and right side, top and bottom screws. Also remove the rear left and right bottom screws. Loosen the rear top screws, but do not remove them. The cover can then be swung upward.

8.4 Power supply interior status light fault codes

You can see the lights by looking through the holes in the right side of the power supply. The lights are toward the rear of the power supply.

The PWR (Power) LED is the LED to the right. This LED is solid green when AC is applied to the power supply.

The ST (Status) LED is the LED to the left. This LED will indicate an abnormal or fault condition. The information can be used to diagnose an installation problem such as incorrect input voltage, an overload condition, and power supply output mis-wiring. It will also provide a signal which informs the user that all power supply and microcontroller operating parameters are normal.

Table 7: Power supply status light indications

Status LED			
Color	Flash Rate	Power supply Status	Color and Sequence After Recovered Fault
Green	1 sec on/off	Normal operation	--
Red	On	Overload	Green
Red	¼ sec on/off	Power supply timed out	--
Red	1 sec on/off	Short circuit	--
Red/Yellow	¼ sec on/off	Under voltage	Red/Yellow/Green
Red/Yellow	1 sec on/off	Over voltage	Red/Yellow/Green
Yellow	On	Stop	--
Yellow	0.04 s on/0.06 s off	Phase Loss Detection	--
Green/Red	1 sec on/off	Communication Error	Green

Appendix A: Calculate Airflow Manually

When testing without a computer, or when testing very large or leaky buildings, it may be necessary to calculate the airflow manually.

Note: Manual calculations are really only appropriate for Single Reading Tests. It is possible to do a Multi-Reading Test manually and attempt to plot out the results on log-log graph paper, but it is not recommended.

To calculate airflow

1. Record the Door Fan Range Configuration.
2. Adjust the fan speed to achieve the desired Room Pressure.
3. Record the Fan Pressure (Channel B on the DM-2, lower two gauges on the analog gauge clip).

If using a computer program:

4. Record the indoor and outdoor temperature.
5. Record the airflow direction.
6. Input the induced Room Pressure and the Fan Pressure into the software, and calculate the results.

If calculating manually:

7. When pressurizing (flow towards operator), subtract the Room Pressure from the Fan Pressure to determine the true Fan Pressure.
8. Using the Manual Flow Tables listed in the *DM-2 Operation Manual*, locate the true Fan Pressure in the left column and read the airflow under the appropriate Range Configuration column.

Manually calculated flows may vary from the more accurate computer output for several reasons:

The Fan Pressure is corrected for Room Pressure which is not known so is approximated to equal Fan Pressure.

The computer corrects each input for gauge error.

The computer may add a fan correction factor K4.

In spite of these reasons, manually calculated results will typically be within 2% of the computer result.

When using multiple fans, never add Fan Pressures, they aren't additive. Determine airflows in CFM separately and add the flows together to determine total airflow.

The Manual Flow Tables are listed in the *DM-2 Operation Manual and DM32 Operation Manual*.

Appendix B: Find correct CFM at particular fan pressure

Flow conversion tables can be used to determine correct flow (CFM) at a particular fan pressure (Pa) on PrB. Back pressure should be considered, especially if fan flow is going toward the operator (i.e. when the operator is in the pressurized zone). The DM-2 gauge and the Retrotec self-referencing fans automatically measure back pressure.

The following five tables offer flow data for these situations:

back pressure of 10 Pa for 1000/2000/3000 fans, flow away and toward

back pressure of 50 Pa for 1000/2000/3000 fans, flow away and toward

back pressure of 25 Pa for DU200 fans

Back pressure has the biggest impact when flow is toward the operator, regardless of test direction.

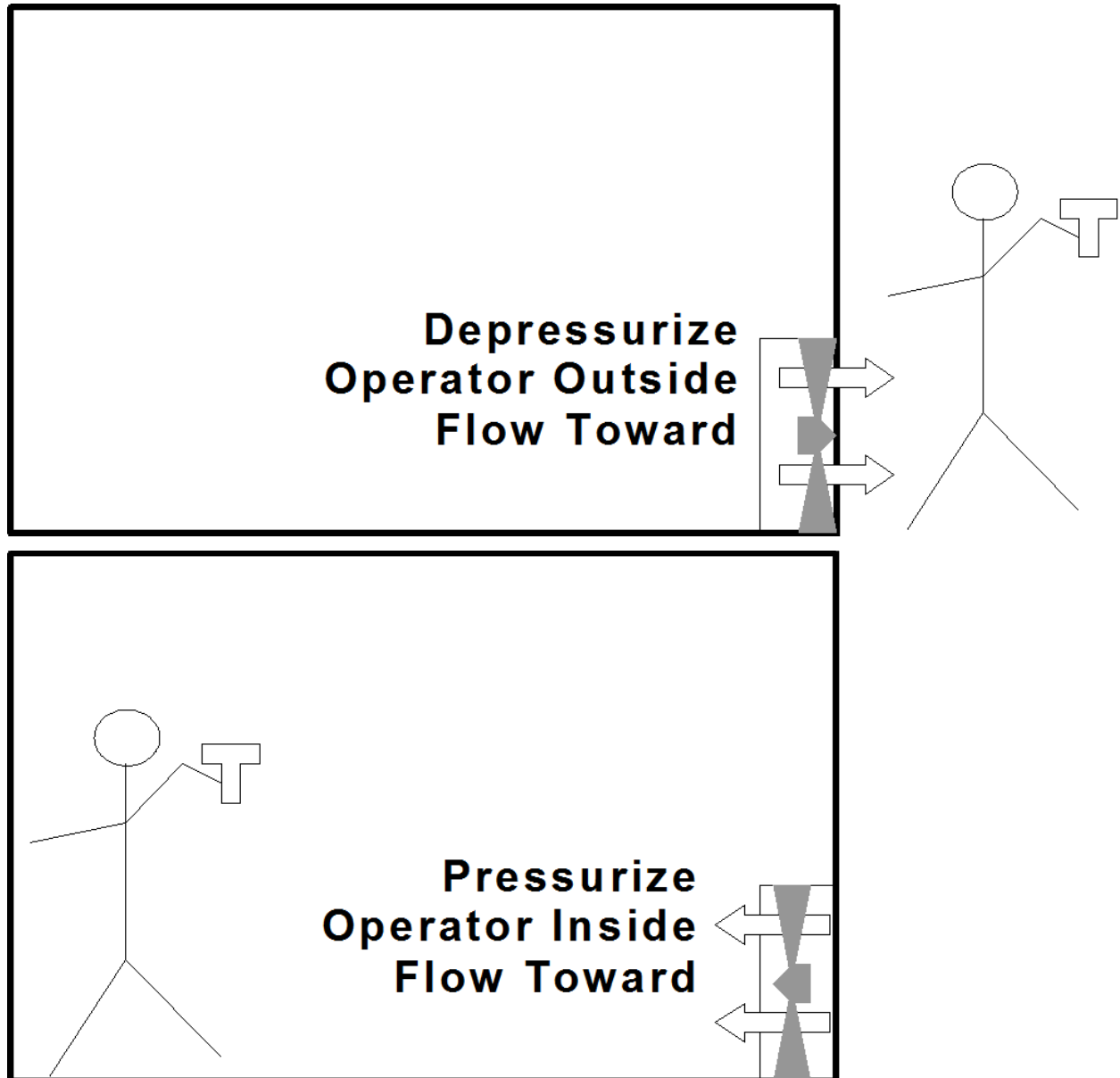

Table 8: Retrotec 1000/2000/3000 series fans. Building Pressure: 10 Pa. Flow: AWAY from the operator. Units in CFM.

Fan Pressure (Pa)	Open	A	B	C8	C6	C4	C2	C1	L4	L2	L1
10	1784	875	553	251	191	123	65	39	12	7	3
12	1950	953	606	275	210	136	73	43	14	7	4
14	2103	1026	654	297	228	148	80	47	15	8	4
16	2247	1094	700	317	245	159	87	51	16	8	4
18	2382	1158	742	336	260	170	94	55	16	9	5
20	2511	1218	782	354	275	180	100	58	17	9	5
22	2633	1276	820	372	289	189	105	62	18	10	5
24	2750	1331	857	388	302	198	111	65	19	10	5
26	2863	1384	892	404	315	206	116	68	20	11	6
28	2971	1435	925	419	327	215	121	71	20	11	6
30	3076	1485	958	434	339	223	126	73	21	11	6
32	3177	1532	989	448	351	230	131	76	22	12	6
34	3276	1579	1020	462	362	238	135	79	22	12	7
36	3371	1624	1049	476	372	245	140	81	23	13	7
38	3464	1668	1078	489	383	252	144	84	24	13	7
40	3555	1711	1106	502	393	259	148	86	24	13	7
42	3643	1752	1133	514	403	266	153	89	25	14	7
44	3729	1793	1160	527	413	272	157	91	25	14	7
46	3813	1833	1186	539	423	279	161	93	26	14	8
48	3896	1872	1212	550	432	285	164	95	26	14	8
50	3977	1910	1237	562	441	291	168	98	27	15	8
52	4056	1948	1261	573	450	297	172	100	27	15	8
54	4133	1984	1285	584	459	303	176	102	28	15	8
56	4209	2021	1309	595	467	309	179	104	28	16	8
58	4284	2056	1332	606	476	315	183	106	29	16	9
60	4358	2091	1355	617	484	320	186	108	29	16	9

Table 9: Retrotec 1000/2000/3000 series Fans. Building Pressure: 50 Pa. Flow: AWAY from the operator. Units in CFM.

Fan Pressure (Pa)	Open	A	B	C8	C6	C4	C2	C1	L4	L2	L1
26			892	410	301	193	101	60		11	5
28			925	425	314	201	106	63		11	5
30			958	440	326	210	112	66		11	6
32			989	454	338	218	117	69		12	6
34			1020	468	350	226	122	72		12	6
36			1049	481	361	233	127	75		13	6
38			1078	494	372	241	132	78		13	7
40	3680		1106	507	382	248	136	80		13	7
42	3766		1133	519	392	255	141	83		14	7
44	3849		1160	531	402	262	145	85		14	7
46	3931		1186	543	412	269	149	88		14	7
48	4011		1212	555	422	275	153	90		14	7
50	4090	1966	1237	566	431	281	157	92	27	15	8
52	4167	2003	1261	578	440	288	161	95	27	15	8
54	4242	2038	1285	589	449	294	165	97	28	15	8
56	4317	2074	1309	599	458	300	169	99	28	16	8
58	4389	2108	1332	610	467	306	173	101	29	16	8
60	4461	2142	1355	621	475	311	176	103	29	16	8
62	4532	2176	1377	631	484	317	180	105	30	16	9
64	4601	2209	1399	641	492	323	183	107	30	17	9
66	4670	2242	1421	651	500	328	187	109	31	17	9
68	4737	2274	1442	661	508	334	190	111	31	17	9
70	4803	2305	1463	671	516	339	194	113	32	18	9
72	4869	2337	1484	681	524	344	197	115	32	18	9
74	4933	2367	1504	690	531	349	200	117	33	18	9
76	4997	2398	1525	700	539	354	203	119	33	18	10
78	5059	2428	1545	709	546	359	206	120	33	18	10
80	5121	2458	1564	718	554	364	210	122	34	19	10
82	5182	2487	1584	727	561	369	213	124	34	19	10
84	5243	2516	1603	736	568	374	216	126	35	19	10
86	5302	2545	1622	745	575	379	219	128	35	19	10

88	5361	2573	1641	754	582	384	222	129	35	20	10
90	5419	2601	1659	763	589	388	225	131	36	20	10
92	5477	2629	1677	771	596	393	227	133	36	20	11
94	5534	2656	1696	780	603	398	230	134	37	20	11
96	5590	2683	1713	788	609	402	233	136	37	21	11
98	5645	2710	1731	797	616	407	236	138	37	21	11
100	5700	2737	1749	805	623	411	239	139	38	21	11
102	5755	2763	1766	813	629	415	241	141	38	21	11
104	5808	2790	1783	821	636	420	244	142	38	21	11
106	5862	2816	1801	830	642	424	247	144	39	22	11

Table 9: continued: Retrotec 1000/2000/3000 series Fans. Building Pressure: 50 Pa. Flow: AWAY from the operator. Units in CFM.

Fan Pressure (Pa)	Open	A	B	C8	C6	C4	C2	C1	L4	L2	L1
108	5914	2841	1817	838	648	428	250	145	39	22	11
110	5967	2867	1834	846	655	433	252	147	40	22	12
115	6095	2929	1875	865	670	443	259	151	40	23	12
120	6220	2991	1916	885	685	453	265	155	41	23	12
125	6342	3051	1955	904	700	463	271	158	42	23	12
130	6462	3110	1994	922	715	473	277	162	43	24	13
135	6579	3168	2032	941	729	482	283	165	44	24	13
140	6694	3225	2069	959	743	492	289	169	45	25	13
145	6806	3281	2106	977	757	501	295	172	45	25	13
150	6916	3336	2142	994	770	510	300	175	46	26	14
155	7024	3390	2177	1011	784	519	306	179	47	26	14
160	7130	3443	2212	1029	797	528	311	182	48	27	14
165	7234	3496	2246	1045	810	537	317	185	48	27	14
170	7336	3547	2280	1062	822	545	322	188	49	27	15
175	7436	3598	2313	1079	835	554	327	191	50	28	15
180	7535	3649	2346	1095	847	562	332	194	50	28	15
185	7632	3698	2379	1111	860	570	337	197	51	29	15

190	7727	3747	2411	1127	872	578	342	200	52	29	15
195	7821	3796	2442	1143	884	586	347	203	52	29	16
200	7913	3843	2473	1158	896	594	352	206	53	30	16
205	8004	3891	2504	1174	907	602	357	209	54	30	16
210	8094	3937	2534	1189	919	609	361	212	54	31	16
215	8182	3983	2564	1204	930	617	366	215	55	31	16
220	8269	4029	2594	1219	942	624	370	217	56	31	17
225	8354	4074	2623	1234	953	632	375	220	56	32	17
230	8438	4118	2652	1249	964	639	379	223	57	32	17
235	8521	4162	2681	1264	975	647	384	225	58	32	17
240	8603	4206	2709	1278	986	654	388	228	58	33	17
245	8684	4249	2737	1293	996	661	392	231	59	33	18
250	8764	4292	2765	1307	1007	668	397	233	59	33	18
255	8842	4334	2793	1321	1018	675	401	236	60	34	18
260	8920	4376	2820	1335	1028	682	405	238	61	34	18
265	8996	4418	2847	1349	1038	689	409	241	61	34	18
270	9072	4459	2874	1363	1049	695	413	243	62	35	19
275	9147	4500	2900	1377	1059	702	417	246	62	35	19
280	9220	4540	2926	1391	1069	709	421	248	63	35	19
285	9293	4580	2952	1405	1079	715	425	251	64	36	19
290	9365	4620	2978	1418	1089	722	429	253	64	36	19
295	9435	4659	3004	1432	1099	729	433	256	65	36	19
300	9505	4698	3029	1445	1109	735	436	258	65	37	20

Table 10: Retrotec 1000/2000/3000 series Fans. Building Pressure: 10 Pa. Flow: TOWARDS the operator. Units in CFM.

Fan Pressure (Pa)	Open	A	B	C8	C6	C4	C2	C1	L4	L2	L1
14			350					21			
16			428	196	145	92	46	28		5	3

18	1602		495	225	169	108	56	34		6	3
20	1784	875	553	251	191	123	65	39	12	7	3
22	1950	953	606	275	210	136	73	43	14	7	4
24	2103	1026	654	297	228	148	80	47	15	8	4
26	2247	1094	700	317	245	159	87	51	16	8	4
28	2382	1158	742	336	260	170	94	55	16	9	5
30	2511	1218	782	354	275	180	100	58	17	9	5
32	2633	1276	820	372	289	189	105	62	18	10	5
34	2750	1331	857	388	302	198	111	65	19	10	5
36	2863	1384	892	404	315	206	116	68	20	11	6
38	2971	1435	925	419	327	215	121	71	20	11	6
40	3076	1485	958	434	339	223	126	73	21	11	6
42	3177	1532	989	448	351	230	131	76	22	12	6
44	3276	1579	1020	462	362	238	135	79	22	12	7
46	3371	1624	1049	476	372	245	140	81	23	13	7
48	3464	1668	1078	489	383	252	144	84	24	13	7
50	3555	1711	1106	502	393	259	148	86	24	13	7
52	3643	1752	1133	514	403	266	153	89	25	14	7
54	3729	1793	1160	527	413	272	157	91	25	14	7
56	3813	1833	1186	539	423	279	161	93	26	14	8
58	3896	1872	1212	550	432	285	164	95	26	14	8
60	3977	1910	1237	562	441	291	168	98	27	15	8
62	4056	1948	1261	573	450	297	172	100	27	15	8
64	4133	1984	1285	584	459	303	176	102	28	15	8
66	4209	2021	1309	595	467	309	179	104	28	16	8
68	4284	2056	1332	606	476	315	183	106	29	16	9

Table 11: Retrotec 1000/2000/3000 series Fans. Building Pressure: 50 Pa. Flow: TOWARDS the operator. Units in CFM.

Fan Pressure (Pa)	Open	A	B	C8	C6	C4	C2	C1	L4	L2	L1
66			700								
68			742								
70			782					50			
72			820					53			
74			857					57			
76			892	410	301	193	101	60		11	5
78			925	425	314	201	106	63		11	5
80			958	440	326	210	112	66		11	6
82			989	454	338	218	117	69		12	6
84			1020	468	350	226	122	72		12	6
86			1049	481	361	233	127	75		13	6
88			1078	494	372	241	132	78		13	7
90	3680		1106	507	382	248	136	80		13	7
92	3766		1133	519	392	255	141	83		14	7
94	3849		1160	531	402	262	145	85		14	7

96	3931		1186	543	412	269	149	88		14	7
98	4011		1212	555	422	275	153	90		14	7
100	4090	1966	1237	566	431	281	157	92	27	15	8
102	4167	2003	1261	578	440	288	161	95	27	15	8
104	4242	2038	1285	589	449	294	165	97	28	15	8
106	4317	2074	1309	599	458	300	169	99	28	16	8
108	4389	2108	1332	610	467	306	173	101	29	16	8
110	4461	2142	1355	621	475	311	176	103	29	16	8
112	4532	2176	1377	631	484	317	180	105	30	16	9
114	4601	2209	1399	641	492	323	183	107	30	17	9
116	4670	2242	1421	651	500	328	187	109	31	17	9
118	4737	2274	1442	661	508	334	190	111	31	17	9
120	4803	2305	1463	671	516	339	194	113	32	18	9
122	4869	2337	1484	681	524	344	197	115	32	18	9
125	4965	2383	1515	695	535	352	202	118	33	18	9
130	5121	2458	1564	718	554	364	210	122	34	19	10
135	5272	2530	1612	741	572	377	217	127	35	19	10
140	5419	2601	1659	763	589	388	225	131	36	20	10
145	5562	2670	1705	784	606	400	232	135	37	20	11
150	5700	2737	1749	805	623	411	239	139	38	21	11
155	5835	2803	1792	826	639	422	246	143	39	21	11
160	5967	2867	1834	846	655	433	252	147	40	22	12
165	6095	2929	1875	865	670	443	259	151	40	23	12
170	6220	2991	1916	885	685	453	265	155	41	23	12
175	6342	3051	1955	904	700	463	271	158	42	23	12
180	6462	3110	1994	922	715	473	277	162	43	24	13
185	6579	3168	2032	941	729	482	283	165	44	24	13
190	6694	3225	2069	959	743	492	289	169	45	25	13
195	6806	3281	2106	977	757	501	295	172	45	25	13

Table 11: continued. Retrotec 1000/2000/3000 series Fans. Building Pressure: 50 Pa. Flow: TOWARDS the operator. Units in CFM.

Fan Pressure (Pa)	Open (22)	A	B	C8	C6	C4	C2	C1	L4	L2	L1
200	6916	3336	2142	994	770	510	300	175	46	26	14
205	7024	3390	2177	1011	784	519	306	179	47	26	14
210	7130	3443	2212	1029	797	528	311	182	48	27	14

215	7234	3496	2246	1045	810	537	317	185	48	27	14
220	7336	3547	2280	1062	822	545	322	188	49	27	15
225	7436	3598	2313	1079	835	554	327	191	50	28	15
230	7535	3649	2346	1095	847	562	332	194	50	28	15
235	7632	3698	2379	1111	860	570	337	197	51	29	15
240	7727	3747	2411	1127	872	578	342	200	52	29	15
245	7821	3796	2442	1143	884	586	347	203	52	29	16
250	7913	3843	2473	1158	896	594	352	206	53	30	16
255	8004	3891	2504	1174	907	602	357	209	54	30	16
260	8094	3937	2534	1189	919	609	361	212	54	31	16
265	8182	3983	2564	1204	930	617	366	215	55	31	16
270	8269	4029	2594	1219	942	624	370	217	56	31	17
275	8354	4074	2623	1234	953	632	375	220	56	32	17
280	8438	4118	2652	1249	964	639	379	223	57	32	17
285	8521	4162	2681	1264	975	647	384	225	58	32	17
290	8603	4206	2709	1278	986	654	388	228	58	33	17
295	8684	4249	2737	1293	996	661	392	231	59	33	18
300	8764	4292	2765	1307	1007	668	397	233	59	33	18

Appendix C: Find Door Fan System Part Numbers

Fans & Accessories			
Part #	Product	Part #	Product
FN150 (120V, 60Hz) FN151 (110V, 50 Hz) FN152 (240V, 50 Hz)	1000 Fan 	FN208 (120V, 60Hz) FN209 (240V, 50 Hz)	2350 Fan (Q46, Q56 systems) 
FN252 (120V, 60Hz) FN256 (240V, 50 Hz)	Fan Top for 2350 Fan (Q46, Q56 systems)	FN309	3300SR Fan for use with high power drive (Q4E, Q5E, QMG systems) 
			
FN310 (240V, 50 Hz) FN311 (120V, 60Hz) FN312 (110V, 50 Hz)	Drive for high power fan (Q4E, Q5E, QMG systems) 	FN214 (Range A Ring for 1000 fan) FN216 (Range A Ring for 2000/3000 fan) FN217 (Range Ring B) FN218 (Range Plate) FN219 (8 Range Plugs)	Range Rings/Plate/Plugs 
			
FN211		FN229	

	<p>Hard Sided Fan Case (2000, 3000 systems)</p> 	<p>Cover for Front or Back of Fan (for 2000/3000 series fans)</p> 
--	---	---

Aluminum Frame

Aluminum Frame dimensions.

Dimensions		With Extender Kit
Panel width	24.5 - 41.5 in (62.2 - 105.4 cm)	30 - 48 in (76 - 122 cm)
Panel height	51.5 - 95 in (131 - 241 cm)	60 - 110 in (152 - 280 cm)
Frame thickness	1.75 in (5.3 cm)	
Frame case	53 x 10 x 4 in (134 x 25 x 10 cm)	
Frame weight	14.2 lbs (6.4 kg)	

AL110	Aluminum Frame with Slots, Red Anodized	AL215	Extender Kits for height & width, Red
			
AL112	Crossbar #6, upper, Red	AL106	Aluminum Frame Cam Lever Replacement Kit

			
AL107	Aluminum Frame Replacement Knob	AL113	Alum Frame Replacement Channel Guide Kit (5 Units)
			
AL114	Alum Frame Replacement Corner Block Kit (Single)	AL115	Alum Frame Replacement Expander Block Kit (Single)
			
AL103	Case for Standard Aluminum Frame, Gun Style	PT111	Aluminum Frame Weather Strip Kit
			Picture of weather strip kit

Cloth Door Panels			
AL203	Cloth for 1000/2000/3000 Fan, Regular Height	AL211	Cloth for 1000/2000/3000 Fan, Extra Tall & Wide (for use with Extender Kit)



			
AL206	Cloth for 3000 fan, High Pressure	AL204	Cloth for 2 x 1000/2000/3000 Fans
			
AL214	Cloth for Low-Flow Fan		
			

Modular Door Panels





<p>PN201</p>	<p>Modular Door Panel Set (includes carrying case)</p> 	<p>PN206R</p>	<p>Fan Panel</p> 
<p>PN207</p>	<p>Large Fill-in Sheet For Fan Panel (for use when Fan Panel is extended out)</p> 	<p>PN208</p>	<p>Small Fill-in Sheet for Fan Panel</p> 
<p>PN210</p>	<p>Large-X Panel</p> 	<p>PN211</p>	<p>XY Panel</p> 

<p>PN209</p> 	<p>Small-X Panel</p>	<p>PN213</p>	<p>Field Verification Plate for Modular Door Panel</p> 
<p>PT112</p>	<p>Weather Strip Repair Kit for Modular Panel (1 panel) Picture of the weather strip</p>	<p>PT110</p>	<p>Weather Strip Repair Kit for Modular Door Panel (4 panels) Picture of the weather strip</p>
<p>PN212</p>	<p>2000/3000 Fan Panel Blanking Plate</p> 	<p>PN204</p>	<p>Panel Case with Shoulder Strap</p> 
<p>PN302</p>	<p>3-Fan Molded Panel Set for 2000/3000 fans (includes 3-Fan Cordura Panel Case)</p> 	<p>PN311</p>	<p>3-Fan Molded Panel Cordura Panel Case</p> 
<p>FN234</p>	<p>Fan Safety Strap for Modular Door Panels (for securing Door Fan onto Door Panel)</p> 		

Digital Gauges

DM221	DM-2A Mark II 2-channel Digital Gauge with Automatic Control	DM32	
			

System Accessories

DM235 DM218 DM224 DM241	Umbilical for 1000 fan, 6.5ft (2m) Umbilical for 2000 fan, 20ft (7m) Umbilical for 3300SR fan, 20ft (7m) Multi-fan Umbilical, 75ft (22.5m)	DM222	Optional Umbilical extension for 3300 fans, 75 ft (22.5 m) (includes DM-2 Umbilical Extender box)
			
DM229	DM-2 Umbilical extender (box only)	DM212	USB Cable Type A to Mini B - 6ft (2m) (for connecting DM-2 to computer for automatic fan control and data retrieval using Retrotec FanTestic software)
			
FN280		DM205	

	7 Fan Control Cable Splitter (requires Control Cable: DM205)		Control Cable for 1000/2000/3000 Digital Fan - 20ft (7m) 
DM203 (120v or 240v)	9V Country Specific Power Supply DM-2 	TU119	Tubing Accessory Kit  (Includes green, yellow, red, and blue tubes (37 ft); Static pressure probe, copper tube, T-connector, male-to-male connector)
CU230	Manual Speed Control (requires Control Cable: DM205) 	FX201 Imperial FX202 Metric	1000/2000/3000 Flex Duct (24") 
TU101	Basic Wind Damping Kit	TU103	Wild Wind Tamer Wind Damping Kit

			
GR113	<p>Grill Mask 12in x 160ft, 12in perfs, hi-stick single roll</p> 	GR106	<p>Grill Mask Dispenser 13in</p> 
	<p>Grill Mask, Case of three</p> 	AC107	<p>Air Current Tester</p> 

Appendix D: Optional Door Fan system components

Flex Duct to measure air flow or neutralize pressure drops

Flex Duct is available in two sizes. A 12-foot long, 24-inch diameter Flex Duct is compatible with all Retrotec Door Fans, and can be used to neutralize the pressure difference across a dropped ceiling, below a raised floor, or to measure the air flow through large registers and vents. When using the Flex Duct, it's important to extend it out to its full length in a straight line.



Figure 37: Flex Duct for Door Fans (mainly used for enclosure integrity testing).

A smaller, 10-inch diameter Flex Duct is included with all Retrotec duct testing systems, and makes it easy to direct the fan airflow into the duct system.

Flex Duct can also be used to check the calibration of a Door Fan system, if a panel with a hole of a known size is attached to the opposite end. For more information, see [Field Verification](#).



Wind Damping Kits to minimize wind effects

Wind Damping Kits help to minimize the effect of wind on an exterior reference pressure tube. For more information about dealing with problems, see [Troubleshooting](#).



Figure 38: Basic wind-damping kit.



Figure 39: Deluxe "wild wind tamer" wind-damping kit.

Cases and Bags

Sturdy cases or bags are available for all Retrotec equipment. Fan cases can protect your fan from damage during transport, and make it easier to carry on location. Replacement bags are available if needed.

All Retrotec bags are hard sided, and made of a durable nylon weave that is hard to tear and is weather resistant.



Figure 40: Carrying cases for fans.

Grill Mask and Dispensers

Grill mask is useful for sealing both supply and return registers, and attaching the flex duct flange. Standard rolls are 12 inches wide.

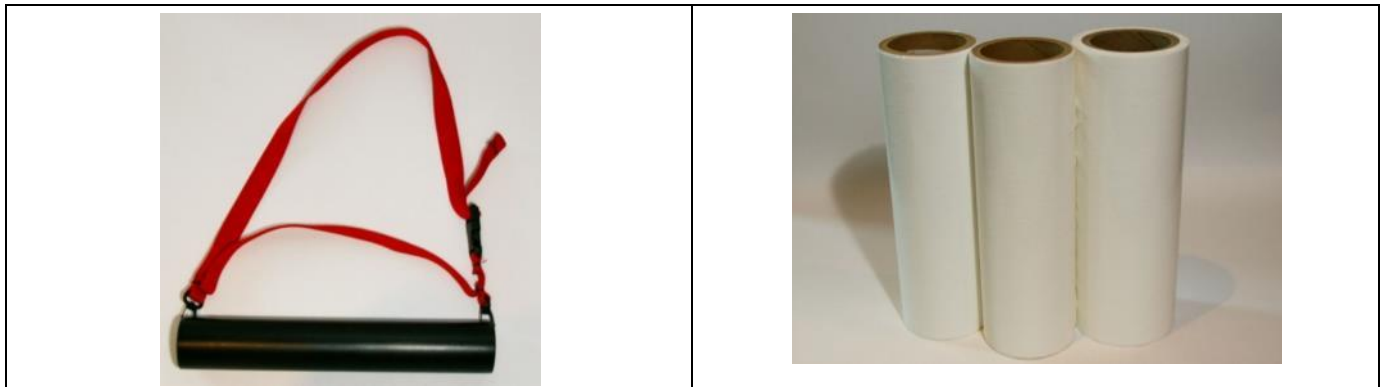

Figure 41: Grill mask dispenser (left) and rolls (right).

Air Current Testers

Retrotec Air Current Testers produce a neutral buoyancy smoke which can be a useful tool in locating air leaks. Even a small puff of smoke will immediately follow the direction of air movement.



Figure 42: Air current testers.

Appendix E: Model and System Names

Naming conventions for Series 1000, 3000, 4000 Blower Door Systems with 22 inch fan shells

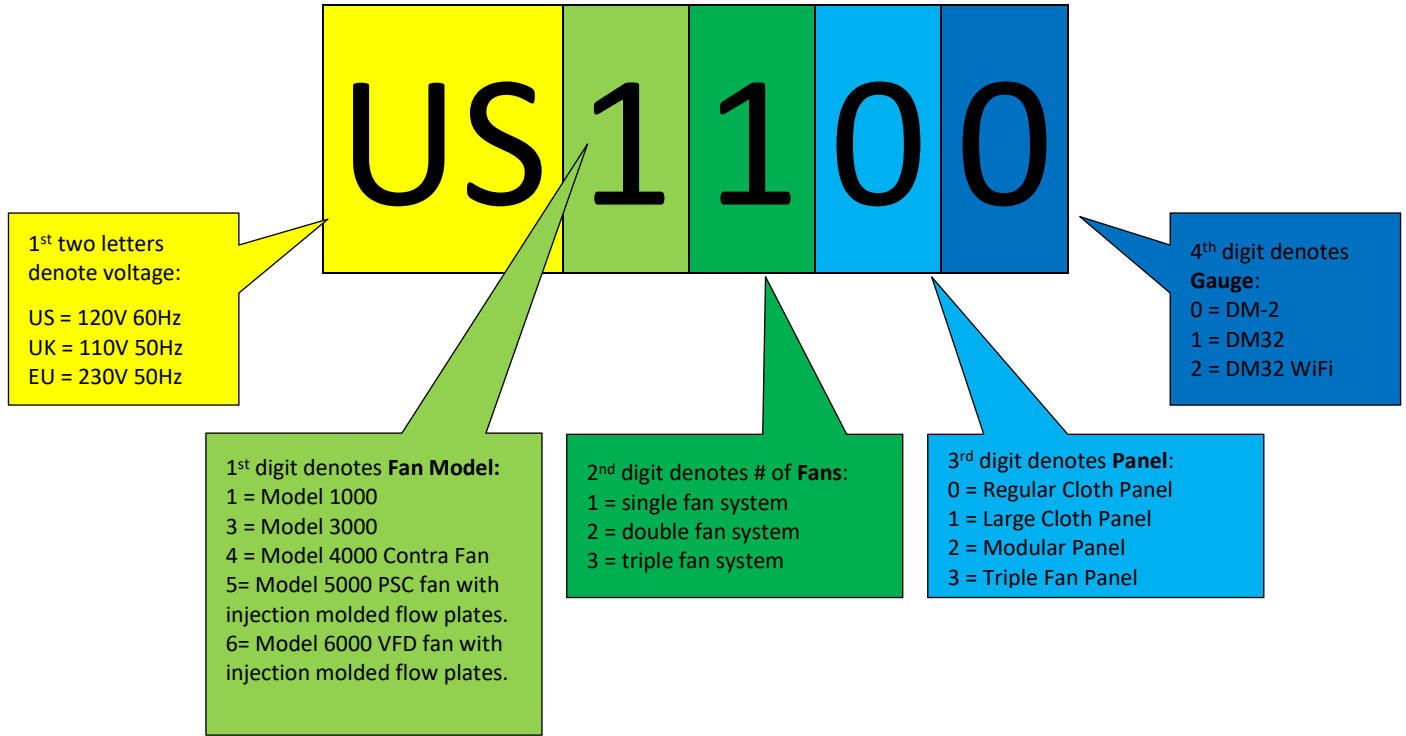

Naming conventions for Series 200, 300, 400 Systems with 10 inch fan shells

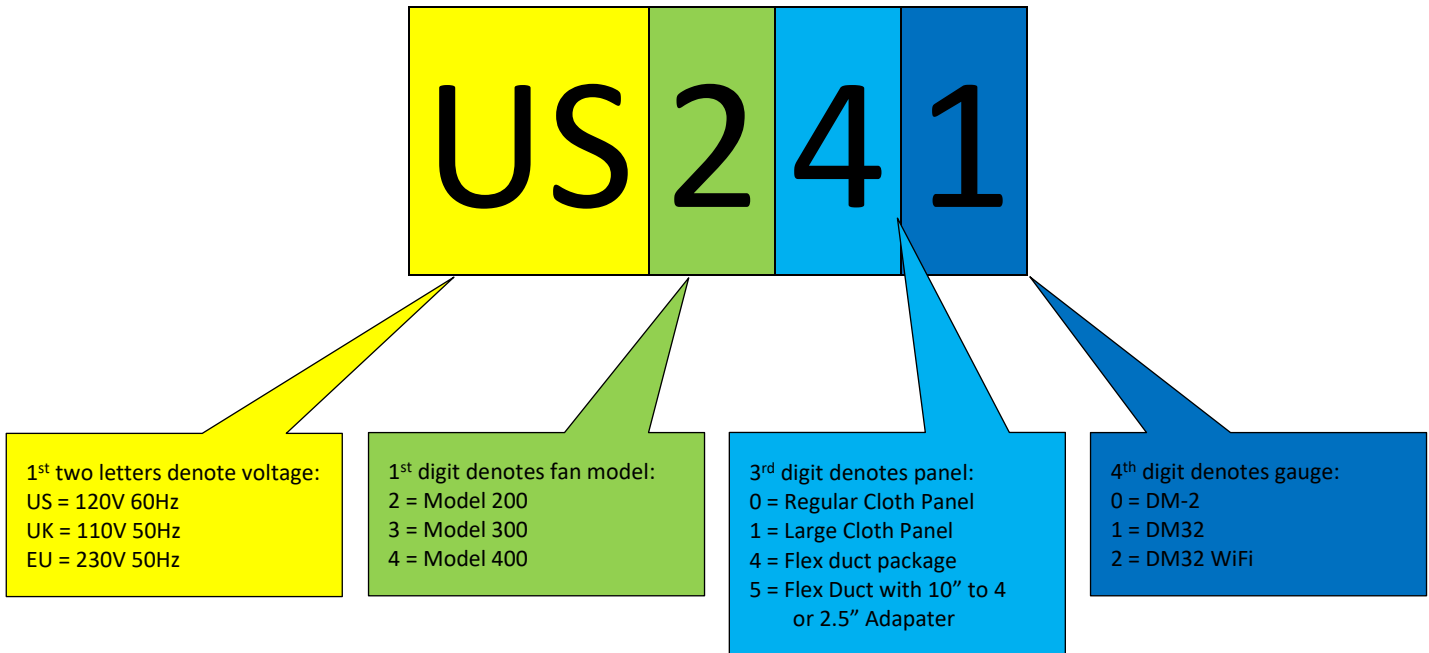

Residential and Commercial Multi Family For: 120V/60Hz, commonly used in North America, System Prefix = US

Name used prior to 2013-07-15	Model Number	Model Name With DM2	Model Number	Model Name with DM32. "1" at the end signifies DM32	Model Number with	Model Name with DM32 Wi-Fi, "2" at the end signifies DM32 with WiFi

	With DM2		with DM32		DM32 Wi-Fi	
DU200 DucTester	US240	Model US240 DucTester with DM-2	US241	Model US241 DucTester with DM32	US242	Model US242 DucTester with DM32 WIFI
US200 Blower Door	US200	Model US200 with Cloth Panel and DM-2	US201	Model US201 with Cloth Panel and DM32	US202	Model US202 with Cloth Panel and DM32 WIFI
US210 Blower Door Large Cloth Panel	US210	Model US210 with Large Cloth Panel and DM-2	US211	Model US211 with Large Cloth Panel and DM32	US212	Model US212 with Large Cloth Panel and DM32 WIFI
US1000 Blower Door	US1100	Model US1100 with Cloth Panel and DM-2	US1101	Model US1101 with Cloth Panel and DM32	US1102	Model US1102 with Cloth Panel and DM32 WIFI
New US1000 Large Cloth Panel	US1110	Model US1110 with Large Cloth Panel and DM-2	US1111	Model US1111 with Large Cloth Panel and DM32	US1112	Model US1112 with Large Cloth Panel and DM32 WIFI
New 2 fan US1000 Large Cloth Panel	US1210	Model US1210 Double Fan with Large Cloth Panel and DM-2	US1211	Model US1211 Double Fan with Large Cloth Panel and DM32	US1212	Model US1212 Double Fan with Large Cloth Panel and DM32 WIFI
New 3 Fan US1000 Large Cloth Panel	US1310	Model US1310 Triple Fan with Large Cloth Panel and DM-2	US1311	Model US1311 Triple Fan with Large Cloth Panel and DM32	US1312	Model US1312 Triple Fan with Large Cloth Panel and DM32 WIFI
Q4E	US3100	Model US3100 with Cloth Panel and DM-2	US3101	Model US3101 with Cloth Panel and DM32	US3102	Model US3102 with Cloth Panel and DM32 WIFI
New Q4E Large Cloth Panel	US3110	Model US3110 with Large Cloth Panel and DM-2	US3111	Model US3111 with Large Cloth Panel and DM32	US3112	Model US3112 with Large Cloth Panel and DM32 WIFI
New 2 fan Q4E Large Cloth Panel	US3210	Model US3210 Double Fan with Large Cloth Panel and DM-2	US3211	Model US3211 Double Fan with Large Cloth Panel and DM32	US3212	Model US3212 Double Fan with Large Cloth Panel and DM32 WIFI
New 3 Fan Q4E Large Cloth Panel	US3310	Model US3310 Triple Fan with Large Cloth Panel and DM-2	US3311	Model US3311 Triple Fan with Large Cloth Panel and DM32	US3312	Model US3312 Triple Fan with Large Cloth Panel and DM32 WIFI
Q5E	US3120	Model US3120 with Hard Panel and DM-2	US3121	Model US3121 with Hard Panel and DM32	US3122	Model US3122 with Hard Panel and DM32 WIFI
QMG	US3330	Model US3330 Triple Fan with Folding Panel and DM-2	US3331	Model US3331 Triple Fan with Folding Panel and DM32	US3332	Model US3332 Triple Fan with Folding Panel and DM32 WIFI
New System Large Cloth Panel Contra Fan	US4210	Model US4210 Double Contra Fan with Large Cloth Panel and DM-2	US4211	Model US4211 Double Contra Fan with Large Cloth Panel and DM32	US4212	Model US4212 Double Contra Fan with Large Cloth Panel and DM32 WIFI

For: 110V/50Hz, commonly used in the UK, System Prefix = UK **When ordering a 240 V unit for the UK, use EU**

Name used prior to 2013-07-15	Model Number	Model Name With DM2	Model Number	Model Name with DM32. "1" at the end signifies DM32	Model Number with	Model Name with DM32 Wi-Fi, "2" at the end signifies DM32 with Wi-Fi
-------------------------------	--------------	---------------------	--------------	---	-------------------	--

	With DM2		with DM32		DM32 Wi-Fi	
DK200 DucTester	UK240	Model UK240 DucTester with DM-2	UK241	Model UK241 DucTester with DM32	UK242	Model UK242 DucTester with DM32 WIFI
UK200 Blower Door	UK200	Model UK200 with Cloth Panel and DM-2	UK201	Model UK201 with Cloth Panel and DM32	UK202	Model UK202 with Cloth Panel and DM32 WIFI
UK210 Blower Door Large Cloth Panel	UK210	Model UK210 with Large Cloth Panel and DM-2	UK211	Model UK211 with Large Cloth Panel and DM32	UK212	Model UK212 with Large Cloth Panel and DM32 WIFI
UK1000 Blower Door	UK1100	Model UK1100 with Cloth Panel and DM-2	UK1101	Model UK1101 with Cloth Panel and DM32	UK1102	Model UK1102 with Cloth Panel and DM32 WIFI
New UK1000 Large Cloth Panel	UK1110	Model UK1110 with Large Cloth Panel and DM-2	UK1111	Model UK1111 with Large Cloth Panel and DM32	UK1112	Model UK1112 with Large Cloth Panel and DM32 WIFI
New 2 fan UK1000 Large Cloth Panel	UK1210	Model UK1210 Double Fan with Large Cloth Panel and DM-2	UK1211	Model UK1211 Double Fan with Large Cloth Panel and DM32	UK1212	Model UK1212 Double Fan with Large Cloth Panel and DM32 WIFI
New 3 Fan UK1000 Large Cloth Panel	UK1310	Model UK1310 Triple Fan with Large Cloth Panel and DM-2	UK1311	Model UK1311 Triple Fan with Large Cloth Panel and DM32	UK1312	Model UK1312 Triple Fan with Large Cloth Panel and DM32 WIFI
Q4E	UK3100	Model UK3100 with Cloth Panel and DM-2	UK3101	Model UK3101 with Cloth Panel and DM32	UK3102	Model UK3102 with Cloth Panel and DM32 WIFI
New Q4E Large Cloth Panel	UK3110	Model UK3110 with Large Cloth Panel and DM-2	UK3111	Model UK3111 with Large Cloth Panel and DM32	UK3112	Model UK3112 with Large Cloth Panel and DM32 WIFI
New 2 fan Q4E Large Cloth Panel	UK3210	Model UK3210 Double Fan with Large Cloth Panel and DM-2	UK3211	Model UK3211 Double Fan with Large Cloth Panel and DM32	UK3212	Model UK3212 Double Fan with Large Cloth Panel and DM32 WIFI
New 3 Fan Q4E Large Cloth Panel	UK3310	Model UK3310 Triple Fan with Large Cloth Panel and DM-2	UK3311	Model UK3311 Triple Fan with Large Cloth Panel and DM32	UK3312	Model UK3312 Triple Fan with Large Cloth Panel and DM32 WIFI
Q5E	UK3120	Model UK3120 with Hard Panel and DM-2	UK3121	Model UK3121 with Hard Panel and DM32	UK3122	Model UK3122 with Hard Panel and DM32 WIFI
QMG	UK3330	Model UK3330 Triple Fan with Folding Panel and DM-2	UK3331	Model UK3331 Triple Fan with Folding Panel and DM32	UK3332	Model UK3332 Triple Fan with Folding Panel and DM32 WIFI
New System Large Cloth Panel	UK4210	Model UK4210 Double Contra Fan with Large Cloth Panel and DM-2	UK4211	Model UK4211 Double Contra Fan with Large Cloth Panel and DM32	UK4212	Model UK4212 Double Contra Fan with Large Cloth Panel and DM32 WIFI

For: 240V/50Hz, commonly used in the Europe, System Prefix = EU

Name used prior to 2013-07-15	Model Number	Model Name With DM2	Model Number	Model Name with DM32. "1" at the end signifies DM32	Model Number with	Model Name with DM32 Wi-Fi, "2" at the end signifies DM32 with WIFI
-------------------------------	--------------	---------------------	--------------	---	-------------------	---

	With DM2		with DM32		DM32 Wi-Fi	
DE200 DucTester	EU240	Model EU240 DucTester with DM-2	EU241	Model EU241 DucTester with DM32	EU242	Model EU242 DucTester with DM32 WIFI
EU200 Blower Door	EU200	Model EU200 with Cloth Panel and DM-2	EU201	Model EU201 with Cloth Panel and DM32	EU202	Model EU202 with Cloth Panel and DM32 WIFI
EU210 Blower Door Large Cloth Panel	EU210	Model EU210 with Large Cloth Panel and DM-2	EU211	Model EU211 with Large Cloth Panel and DM32	EU212	Model EU212 with Large Cloth Panel and DM32 WIFI
EU1000 Blower Door	EU1100	Model EU1100 with Cloth Panel and DM-2	EU1101	Model EU1101 with Cloth Panel and DM32	EU1102	Model EU1102 with Cloth Panel and DM32 WIFI
New EU1000 Large Cloth Panel	EU1110	Model EU1110 with Large Cloth Panel and DM-2	EU1111	Model EU1111 with Large Cloth Panel and DM32	EU1112	Model EU1112 with Large Cloth Panel and DM32 WIFI
New 2 fan EU1000 Large Cloth Panel	EU1210	Model EU1210 Double Fan with Large Cloth Panel and DM-2	EU1211	Model EU1211 Double Fan with Large Cloth Panel and DM32	EU1212	Model EU1212 Double Fan with Large Cloth Panel and DM32 WIFI
New 3 Fan EU1000 Large Cloth Panel	EU1310	Model EU1310 Triple Fan with Large Cloth Panel and DM-2	EU1311	Model EU1311 Triple Fan with Large Cloth Panel and DM32	EU1312	Model EU1312 Triple Fan with Large Cloth Panel and DM32 WIFI
Q4E	EU3100	Model EU3100 with Cloth Panel and DM-2	EU3101	Model EU3101 with Cloth Panel and DM32	EU3102	Model EU3102 with Cloth Panel and DM32 WIFI
New Q4E Large Cloth Panel	EU3110	Model EU3110 with Large Cloth Panel and DM-2	EU3111	Model EU3111 with Large Cloth Panel and DM32	EU3112	Model EU3112 with Large Cloth Panel and DM32 WIFI
New 2 fan Q4E Large Cloth Panel	EU3210	Model EU3210 Double Fan with Large Cloth Panel and DM-2	EU3211	Model EU3211 Double Fan with Large Cloth Panel and DM32	EU3212	Model EU3212 Double Fan with Large Cloth Panel and DM32 WIFI
New 3 Fan Q4E Large Cloth Panel	EU3310	Model EU3310 Triple Fan with Large Cloth Panel and DM-2	EU3311	Model EU3311 Triple Fan with Large Cloth Panel and DM32	EU3312	Model EU3312 Triple Fan with Large Cloth Panel and DM32 WIFI
Q5E	EU3120	Model EU3120 with Hard Panel and DM-2	EU3121	Model EU3121 with Hard Panel and DM32	EU3122	Model EU3122 with Hard Panel and DM32 WIFI
QMG	EU3330	Model EU3330 Triple Fan with Folding Panel and DM-2	EU3331	Model EU3331 Triple Fan with Folding Panel and DM32	EU3332	Model EU3332 Triple Fan with Folding Panel and DM32 WIFI

New System Large Cloth Panel	EU4210	Model EU4210 Double Contra Fan with Large Cloth Panel and DM-2	EU4211	Model EU4211 Double Contra Fan with Large Cloth Panel and DM32	EU4212	Model EU4212 Double Contra Fan with Large Cloth Panel and DM32 WIFI
------------------------------	--------	--	--------	--	--------	---

Enclosure Integrity

For: 120V/60Hz, commonly used in North America, System Prefix = US

Name used prior to 2013-07-15	Model Number With DM2	Model Name With DM2*	Model Number with DM32 Wi-Fi	Model Name with DM32 Wi-Fi, "2" at the end signifies DM32 with WiFi
US200F Blower Door	US200F	Model US200F with Cloth Panel and DM-2 for Enclosure Integrity	US202F	Model US202F with Cloth Panel and DM32 WIFI for Enclosure Integrity
US210F Blower Door Large Cloth Panel	US210F	Model US210F with Large Cloth Panel and DM-2 for Enclosure Integrity	US212F	Model US212F with Large Cloth Panel and DM32 WIFI for Enclosure Integrity
US1000F Blower Door	US1100F	Model US1100F with Cloth Panel and DM-2 for Enclosure Integrity	US1102F	Model US1102F with Cloth Panel and DM32 WIFI for Enclosure Integrity
New US1000F Large Cloth Panel	US1110F	Model US1110F with Large Cloth Panel and DM-2 for Enclosure Integrity	US1112F	Model US1112F with Large Cloth Panel and DM32 WIFI for Enclosure Integrity
Q4E	US3100F	Model US3100F with Cloth Panel and DM-2 for Enclosure Integrity	US3102F	Model US3102F with Cloth Panel and DM32 WIFI for Enclosure Integrity
New Q4E Large Cloth Panel	US3110F	Model US3110F with Large Cloth Panel and DM-2 for Enclosure Integrity	US3112F	Model US3112F with Large Cloth Panel and DM32 WIFI for Enclosure Integrity
New 2 fan Q4E Large Cloth Panel	US3210F	Model US3210F Double Fan with Large Cloth Panel and DM-2 for Enclosure Integrity	US3212F	Model US3212F Double Fan with Large Cloth Panel and DM32 WIFI for Enclosure Integrity
Q5E	US3120F	Model US3120F with Hard Panel and DM-2 for Enclosure Integrity	US3122F	Model US3122F with Hard Panel and DM32 WIFI for Enclosure Integrity
Q5E-2X	US3220F	Model US3220F Double Fan with Hard Panel and DM-2 for Enclosure Integrity	US3222F	Model US3222F Double Fan with Hard Panel and DM32 WIFI for Enclosure Integrity

Glossary

Term	Definition
Air Changes per Hour	<p>The number or times per hour that the volume of air in the enclosure will flow out of the enclosure. A flow rate normalized to the volume of the enclosure and allows comparison of the “leakiness” of larger volumes to the “leakiness” of smaller volumes. Always expressed in units of /h.</p> <p>Calculated as: General: Flow / Volume</p> <p>Units: $\frac{1}{h}$</p> $= \text{CFM} * \left(\frac{60 \text{ min}}{1 \text{ h}}\right) * \left(\frac{1}{\text{ft}^3}\right) = \left(\frac{\text{m}^3}{\text{h}}\right) * \left(\frac{1}{\text{m}^3}\right) = \left(\frac{\text{m}^3}{\text{s}}\right) * \left(\frac{60 \text{ s}}{1 \text{ min}}\right) * \left(\frac{60 \text{ min}}{1 \text{ h}}\right) * \left(\frac{1}{\text{m}^3}\right)$ $= \left(\frac{1}{\text{s}}\right) * \left(\frac{60 \text{ s}}{1 \text{ min}}\right) * \left(\frac{60 \text{ min}}{1 \text{ h}}\right) * \left(\frac{1 \text{ m}^3}{1000 \text{ l}}\right)$
ACH50 or ACH @ 50 Pa	Designation for “Air Changes at 50 Pa.” Can be calculated by taking CFM50 x 60 minutes/ hour, divided by the house volume.
Air Current Tester	Neutrally buoyant smoke (manufactured by Retrotec) used to locate leakage locations, and to observe the direction of air flow, or to see if pressure neutralization between two zones is reached.
air leakage	Pertains to how leaky an enclosure may be: the movement/flow of air through the building envelope, which is driven by either or both positive (infiltration) or negative (exfiltration) pressure differences or test pressures across the building envelope.
Baseline pressure	Pressure that exists when the enclosure has been prepared for the test, but before the fan pressurization system is activated. There is always some Baseline pressure due to stack, wind, flues and active HVAC systems. There are two components of Baseline pressure. A fixed Baseline offset (usually due to stack or HVAC) and a fluctuating pressure (usually due to wind or elevator operation). A method of determining Baseline pressure is to have a digital gauge accumulate readings over an adjustable time period (Note: The terms “ static pressure ”, “ bias pressure ,” and “ zero Fan Pressure difference ” are used interchangeably with the term Baseline pressure in other documents/standards used in the industry.)
CFM50 or CFM @ 50 Pa	Flow rate, in cubic feet per minute, required to depressurize/pressurize the building to 50 Pascals
Conditioned Space	An area or volume that is normally air-conditioned or heated (i.e. inside the thermal envelope). Even though supply ducts may not discharge directly into these spaces, they are considered “conditioned” if their temperature follows indoor temperature closer than outdoor. (e.g. Any space maintained above 50 °F in winter and below 80 °F in summer)
depressurization	The process of creating a negative pressure in the enclosure by blowing air out of it. Air is drawn in from outside to replace it, showing up as “geysers” when checked with an air current tester.
digital gauge	A gauge with an electronic pressure sensor and digital display that is capable of reading in tenths of a Pascal.
Door Fan	A test instrument that fits into an open doorway in order to pressurize or depressurize an enclosure. It is a calibrated fan capable of measuring air-flow, and is used while mounting it into a doorway. A Door Fan is often called a “ Blower Door ” or an “ Infiltrometer ™”. Door fan is more linguistically correct than the common term “blower door”, since it is not a “door,” but rather a “fan” and since it does not use a “blower.”
Door Panel	A solid or flexible panel used to temporarily seal off a door way while allowing for the installation of a fan for the purpose of blowing air into the building in order to measure the air leakage rate or to provide a pressure to assist in the location of air leaks
Effective Leakage Area (EflA)	A common term used to describe air flow at a pressure by equating it to an equivalent size hole in an elliptical nozzle that would pass the same air flow at the same test pressure. It is usually taken at 4 Pa and incorporates a 1.0 discharge coefficient. It is typically about half the size of an equivalent leakage area that describes the same air flow rate. See ASTM E779-10, eq. (5).
EflA	See “ Effective Leakage Area ”
enclosure	A room, house, or building. For rooms or interior spaces, the enclosure is the surface bounding a volume which is connected to outdoors directly. For example in an apartment whose only access to outdoors was

Term	Definition
	through a doorway that leads directly outdoors, the enclosure is formed by the walls of the apartment. If a building has a series of apartments or offices whose only access to the outdoors is through a common hallway then the enclosure would be the volume that bounds all of the apartments or offices.
Envelope	The surfaces composed of floor and walls and floors that separate the test volume from volume surrounding the test volume. Also see "enclosure"
EqlA	See "Equivalent Leakage Area"
Equivalent Leakage Area (ELA or EqlA)	In layman's terms, the ELA is the size of hole we'd have if all the building's cracks and holes could somehow be brought together. In Engineer's terms: the equivalent size of hole required in a flat plate to give the same flow rate having a discharge coefficient of 0.61 and taken at the Reference Pressure. This ELA is sometimes called the EqlA or Canadian ELA because it was first used in the Canadian GSB air leakage standard for houses. This ELA enjoys worldwide acceptance by most testers, even in the US. This ELA should not be confused with another ELA that is often called the EflA or Effective Leakage Area. It is very unfortunate that both these ELA's have the same acronym of ELA. The EflA was developed for the US ASTM Standard and is smaller than the EqlA by at least a factor of 0.61 because it uses a discharge coefficient of 1.0. This EflA is sometimes called the LBL or Lawrence Berkley Labs ELA because it was developed there and is used in the LBL natural air change model that enjoys wide usage- apart from that usage, the EflA is not used very much but the existence of both can create discrepancies in results that may confuse users. When it is taken at a reference pressure of 75 Pa, it is often referred to as EqlA75. EqlA is typically about twice the size of an Effective Leakage Area that describes the same air flow rate. See ASTM E779-10, eq. (5).
Fan Pressure	The pressure difference between inside the door fan and the surrounding air. This pressure can be read as "PrB" from Channel B on the DM-2. It is used by the computer to calculate the air flow rate through the Door Fan.
HVAC	Heating Ventilating and Air conditioning system.
induced pressure	The pressure difference created by the Door Fan (Test Fan) between inside and outside of the enclosure. This pressure is commonly measured on Channel A of the pressure gauge.
Leakage	A general term used to describe holes or the area of holes in or around an enclosure
Leakage Area	This is the same as "Equivalent Leakage Area" but is not specific as to which kind of leakage
Open Range	A Range configuration on a Retrotec Door Fan – indicates that no Range Rings or Range Plates are attached. It is sometimes referred to as Open (22) Range since its diameter is 22 inches.
outdoors	Outside the building in the area around the building.
Manual Speed Control Knob	The dial that is on a Fan Top to control fan speed
Manual Speed Control Accessory	Separate fan speed controller with a knob to control the speed, provided as an optional accessory if user does not want to use a gauge as speed controller
Pascal (Pa)	Often shown as "Pa". A very small metric unit of pressure. There are 249 Pascals in 1 inch of Water Column (the pressure required to push water up 1" in a tube). One Pascal = 0.000145 psi.
Pressurization	The process of creating a positive pressure in the house by blowing air into the enclosure. Air is pushed out through all the leaks, causing the smoke to move away from the operator when checked with an air current tester
Range configuration	The Range Plate or Range Ring that is used on the fan during a Door Fan test. See Retrotec's <i>Fan Range Configuration QuickGuide</i>
Range Plate	The Range attachment on the Retrotec Door Fan, which holds Ranges C8, C6, C4, C3, C2, C1, L4, L2, and L1. See Retrotec's <i>Fan Range Configuration QuickGuide</i> .
Range Ring	The plastic Range attachments on the Retrotec Door, which include Range A and Range B. See Retrotec's <i>Fan Range Configuration QuickGuide</i> .
Reading	A set of simultaneous Induced (Room) Pressure and Fan Pressure readings. Sometimes referred to as a data set or test point because it is plotted as one point on a graph.
Reference Pressure	The pressure at which a result is calculated. This is usually at the test pressure. For example EqlA is typically referenced to 10 Pa. EqlA is also taken at 25 Pa for some purposes because it tends to be more repeatable. Forced Air Changes per Hour (ACH) are usually referenced to 50 Pa, which is why it is common to see ACH50

Term	Definition
	for air changes at 50 Pa. CFM50 would be the airflow at 50 Pa. In all cases the test may be taken at a pressure close to the reference pressure and then, using a computer, can be extrapolated to calculate the result that would have been observed, had the target reference pressure been achieved.
Room Pressure	The pressure difference created by the Door Fan between inside and outside of the enclosure. (See also “induced pressure”). This pressure is commonly measured by Channel A on the gauge.